

November 2022

# Guide for connection of power generating plants to the low- voltage grid ( $\leq 1$ kV)

Type A and B

Version 1.3

## VERSION LOG

<b>Version</b>	<b>Change</b>	<b>Date</b>
1.0	A translated version of the Danish Guide for Power generating plants LV.	27-04-2018
1.1	Annex B1.2 and B2.1 are updated, so is clear what is covered by the EN50549-1	20-12-2019
1.2	Update of annex	29-10-2021
1.3	Layout update. Updated according to positive list.	18-11-2022

---

**TABLE OF CONTENTS**

<b>Version log .....</b>	<b>2</b>
<b>Table of contents.....</b>	<b>3</b>
<b>1. Introduction .....</b>	<b>5</b>
<b>2. Objective and administrative provisions.....</b>	<b>7</b>
2.1. Purpose.....	7
2.2. Scope .....	8
2.3. Complaints about grid connection of power-generating plants .....	8
2.4. Sanctions in case of noncompliance .....	9
2.5. Exemption from grid connection requirements.....	9
2.6. Determination of voltage level and Point of Connection.....	9
2.7. References.....	9
<b>3. Definitions/Terms .....</b>	<b>11</b>
3.1. Abbreviations.....	11
3.2. Definitions .....	13
<b>4. Requirements for type A power-generating plants.....</b>	<b>26</b>
4.1. Tolerance of frequency and voltage deviations .....	26
4.2. Start-up and reconnection of a power-generating plant.....	28
4.3. Active power control.....	28
4.4. Reactive power control.....	30
4.5. Protection .....	37
4.6. Power quality.....	41
4.7. Exchange of information.....	47
4.8. Verification and documentation.....	48
<b>5. Requirements for type B power-generating plants .....</b>	<b>51</b>
5.1. Immunity to frequency and voltage deviations .....	51
5.2. Start-up and reconnection of a power-generating plant.....	56
5.3. Active power control.....	57
5.4. Reactive power control.....	60
5.5. Protection .....	66
5.6. Power quality.....	71
5.7. Exchange of information.....	76
5.8. Verification and documentation.....	77
<b>Annex 1 Documentation for type A power-generating plants.....</b>	<b>80</b>

## Table of contents

---

<i>B1.1. Documentation for type A power-generating plants</i> .....	80
<i>B1.2. Documentation for type A power-generating plants</i> .....	83
<b>Annex 2 Documentation for type B power-generating plants</b> .....	<b>89</b>
<i>B2.1. Documentation for type B power-generating plants (part 1)</i> .....	89
<i>B2.2. Documentation for type B power-generating plants (part 2)</i> .....	100

## 1. INTRODUCTION

This document describes the requirements for power-generating plants connected to the low-voltage grid. The requirements for power-generating plants are divided into four main types based on the plant's active power capacity:

- A. Plants up to 125 kW
- B. Plants from 125 kW up to 3 MW
- C. Plants from 3 MW up to 25 MW
- D. Plants from 25 MW

This document only contain requirements for power-generating plants of types A and B as only power-generating plants of these types can be connected to the low-voltage grid. Larger power-generating plants are connected to the medium and high-voltage grid.

Requirements for type B power-generating plants are also included in 'Technical requirements for connection of power-generating plants to the medium and high-voltage grid (>1 kV)' as some type B power-generating plants are too large to connect to the low-voltage grid.

Chapter 2 contains the administrative provisions. This chapter describes, among other things, the purpose, statutory authority, appeal procedures and exceptions. The chapter also contains a list of normative and informative references.

Definitions and abbreviations used in these requirements are included in Chapter 3.

Chapters 4 and 5 contain requirements for power-generating plants of types A and B, respectively. All requirements specified in this document apply at the Point of Connection (POC) unless otherwise specified.

If you are to connect a type A plant to the grid, you only need to read chapters 2 and 3, and the chapter on type A power-generating plants, including the relevant annex. This also applies for connection of type B power-generating plants which have their own dedicated chapter and annex.

The term 'power-generating plant' is used to cover **common** requirements for power park modules and synchronous power-generating plants. Where **specific** requirements apply to 'power park modules' or 'synchronous power-generating plants', they are designated as such.

## Introduction

---

For clarity purposes, supplementary or additional requirements for synchronous power-generating plants are marked with **(a)** and for power park modules with **(b)**.

The sections are structured so that general requirements are stated first followed by specific requirements for synchronous power-generating plants and power park modules, respectively.

Green text boxes are included several times in these requirements. Such text boxes do not include requirements; they only contain supplementary information or recommendations.

## 2. OBJECTIVE AND ADMINISTRATIVE PROVISIONS

### 2.1. PURPOSE

The purpose of these requirements is to describe the applicable technical and functional requirements for a plant connected – or planned to be connected – to the public low-voltage distribution grid.

If these requirements are complied with, the plant is deemed to be in compliance with applicable rules and regulations for connection to the public electricity supply grid.

#### 2.1.1. Legal framework and terms and conditions

This guide is written based on the technical requirements set by distribution system operators and Energinet. These requirements are derived from 'COMMISSION REGULATION (EU) 2016/631 of 14 April 2016 establishing a network code on requirements for grid connection of generators'.

In addition, this guide also includes requirements to power-generating plants based on the Danish Electricity Supply Act paragraph 26, 73a, and 73b.

In case of doubt about the interpretation of the technical requirements, the version of the requirements registered with Danish authorities has precedence.

#### 2.1.2. New power-generating plants

New power-generating plants connected to the grid after 27 April 2019 must comply with the requirements set out in these requirements. Existing power-generating plants connected to the grid before this date are exempt from the requirements, see section 2.1.3.

#### 2.1.3. Existing power-generating plants

A plant is considered existing if it was connected to the grid before 27 April 2019 or if the plant owner entered into a final and binding purchase agreement regarding the main generating plant before 17 Maj 2018.

An existing plant must comply with the requirements applicable at the time of connection to the grid, or at the time when the plant owner entered into a final and binding purchase agreement regarding the main generating plant.

#### 2.1.4. Modification of existing power-generating plants

An existing plant, or parts thereof, to which substantial technical modifications are made must comply with the technical and functional requirements provided in these requirements.

## Objective and administrative provisions

---

A substantial modification of a plant changes the electrical properties of the plant at the Point of Connection (POC) and may, for example, include replacement of vital components.

Before any modification is made, the plant owner is obliged to notify the DSO about the modification.

### 2.2. SCOPE

The requirements for power-generating plants are divided into four types based on the plant's active power capacity.

- A. Plants up to 125kW(\*)
- B. Plants from 125kW up to 3MW(\*\*)
- C. Plants from 3MW up to 25MW\*\*
- D. Plants from 25MW\*\*

*(\*) Plants under 0,8 kW are exempted from the requirements in section 4.1.2, 4.2, 4.3, and 4.4, which are requirements set in the RfG.*

*(\*\*) Type B plants can be connected to both the low-voltage grid and the medium-voltage grid depending on the size of the plant. This type is therefore included in both requirements documents.*

*\*\*These plant types are covered in 'Technical requirements for connection of plants to the medium and high-voltage grid (>1 kV)'.*

Back-up power generating units operated in parallel with the public electricity supply grid for less than five minutes per month, excluding unit maintenance and commissioning testing, are not required to comply with the requirements in this document. If the back-up power generating unit is operated for more than five minutes per month in normal operation, the unit must comply with the requirements for power quality and protection as provided in these requirements.

These requirements do not include the financial aspects related to grid connection and settlement metering of power-generating plants.

If a plant comprises both consumption and generation, these will be evaluated separately.

### 2.3. COMPLAINTS ABOUT GRID CONNECTION OF POWER-GENERATING PLANTS

Complaints about the DSO in relation to grid connection of power-generating plants can be lodged with the Danish Utility Regulator.

### 2.4. SANCTIONS IN CASE OF NONCOMPLIANCE

If a plant does not comply with applicable rules and conditions, the DSO may ultimately withdraw the operational notification and disconnect the plant until the requirements are met.

### 2.5. EXEMPTION FROM GRID CONNECTION REQUIREMENTS

It is possible to apply for an exemption from the requirements specified in this document under special circumstances.

The plant owner must send an exemption application to the DSO. Depending on the nature of the application, it will be forwarded to the Danish Utility Regulator, which will make a decision.

An exemption application must contain a detailed description, which at least includes:

- Identification of the plant owner, as well as a contact person.
- A description of the plant(s) which the requested exemption concerns.
- A reference to the provisions which the requested exemption concerns as well as a description of the requested exemption.
- A detailed description of the reasons for the requested exemption supported by relevant documentation and a cost-benefit analysis.
- Documentation showing that the requested exemption does not have an adverse effect on open power trading.

### 2.6. DETERMINATION OF VOLTAGE LEVEL AND POINT OF CONNECTION

The DSO determines the Point of Connection (POC) and associated voltage level in accordance with the provisions of the Danish Electricity Supply Act.

All requirements apply to the Point of Connection (POC), unless otherwise specified.

### 2.7. REFERENCES

#### 2.7.1. Normative

EU Regulation 2016/631

Joint Regulation 2017 (Fællesregulativet 2017)

The Danish Electricity Supply Act (Elforsyningsloven)

**DS/EN 50160:** Voltage characteristics of electricity supplied by public distribution networks.

**prEN 50549-1:** Requirements for generating plants to be connected in parallel with distribution networks – Part 1: Connection to a LV distribution network.

**DS/EN 60038:** IEC/CENELEC standard voltages.

**DS/EN 61000-3-2:** Electromagnetic compatibility (EMC) – Part 3-2: Limits – Limits for harmonic current emissions (equipment input current  $\leq 16A$  per phase).

**DS/EN 61000-3-3:** Electromagnetic compatibility (EMC) – Part 3-3: Limits – Limitation of voltage changes, voltage fluctuations and flicker in public low-voltage supply systems, for equipment with rated current  $\leq 16$  A per phase and not subject to conditional connection.

**DS/EN 61000-3-11:** Electromagnetic compatibility (EMC) – Part 3-11: Limits – Limitation of voltage changes, voltage fluctuations and flicker in public low-voltage supply systems – Equipment with rated current  $\leq 75$  A and subject to conditional connection.

**DS/EN 61000-3-12:** Electromagnetic compatibility (EMC) – Part 3-12: Limits – Limits for harmonic currents produced by equipment connected to public low-voltage systems with input current  $> 16$  A and  $\leq 75$  A per phase.

**DS/EN 61000-4-30:** Electromagnetic compatibility (EMC) – Part 4-30: Testing and measurement techniques – Power quality measurement methods.

**DS/EN 61400-21:2008:** Wind turbines – Part 21: Measurement and assessment of power quality characteristics of grid connected wind turbines.

### 2.7.2. Informative

**IEC/TR 61000-3-14:** Electromagnetic compatibility (EMC) – Part 3-14: Assessment of emission limits for harmonics, interharmonics, voltage fluctuations and unbalance for the connection of disturbing installations to LV power systems.

**IEC/TR 61000-3-15:** Electromagnetic compatibility (EMC) – Part 3-15: Limits – Assessment of low frequency electromagnetic immunity and emission requirements for dispersed generation systems in LV network.

**Research Association of the Danish Electric Utilities (DEFU) report RA 557:** 'Maximum emission of voltage disturbances from wind power plants  $> 11$  kW', June 2010.

**Research Association of the Danish Electric Utilities (DEFU) Recommendation no. 16:** Voltage quality in low-voltage grids.

## 3. DEFINITIONS/TERMS

### 3.1. ABBREVIATIONS

#### 3.1.1. $\psi_k$

$\psi_k$  denotes the short-circuit angle at the Point of Connection (POC).

#### 3.1.2. $C_f$

$C_f$  denotes the flicker co-efficient. For a more detailed description, see DS/EN 61400-21.

#### 3.1.3. $d(\%)$

$d(\%)$  denotes rapid voltage changes. For a more detailed description, see section 3.2.27.

#### 3.1.4. DK1

Western Denmark. For a more detailed description, see 3.2.66.

#### 3.1.5. DK2

Eastern Denmark. For a more detailed description, see 3.2.68.

#### 3.1.6. $df/dt$

$df/dt$  denotes frequency change over time. For a more detailed description, see 3.2.21.

#### 3.1.7. DSO

Distribution system operator, see 3.2.11.

#### 3.1.8. $f_<$

$f_<$  denotes the operational setting for underfrequency in the relay protection.  
For a more detailed description, see sections 4.5 and 5.5.

#### 3.1.9. $f_>$

$f_>$  denotes the operational setting for overfrequency in the relay protection.  
For a more detailed description, see sections 4.5 and 5.5.

#### 3.1.10. $f_{RO}$

$f_{RO}$  denotes the frequency at which a plant is to begin downward regulation with the agreed droop. For a more detailed description, see sections 4.3.1 and 5.3.1.

#### 3.1.11. $I_h$

$I_h$  denotes individual harmonic currents, where  $h$  denotes the harmonic order.

#### 3.1.12. $I_n$

$I_n$  denotes nominal current. For a more detailed description, see 3.2.42.

#### 3.1.13. $I_Q$

$I_Q$  denotes fast fault current. For a more detailed description, see 3.2.52.

### 3.1.14. $k_u$

$k_u$  denotes voltage change factor. The voltage change factor is calculated as a function of  $\psi_k$ .

### 3.1.15. $P_n$

$P_n$  denotes nominal active power. For a more detailed description, see 3.2.39.

### 3.1.16. $P_{lt}$

$P_{lt}$  denotes long-term flicker emissions from a plant.  $P_{lt}$  stands for 'long term' and is evaluated over a period of two hours. For a more detailed description, see IEC 61000-3-7.

### 3.1.17. $P_{st}$

$P_{st}$  denotes short-term flicker emissions from a plant.  $P_{st}$  stands for 'short term' and is evaluated over a period of ten minutes. For a more detailed description, see IEC 61000-3-7.

### 3.1.18. PCC

Abbreviation for Point of Common Coupling. For a more detailed description, see 3.2.36.

### 3.1.19. PCI

Abbreviation for Point of Connection in Installation. For a more detailed description, see 3.2.29.

### 3.1.20. PCOM

Abbreviation for Point of Communication. PCOM is defined in section 3.2.32.

### 3.1.21. $P_d$

$P_d$  denotes design power. For a more detailed description, see 3.2.7.

### 3.1.22. PF

Abbreviation for Power Factor. For a more detailed description, see 3.2.9.

### 3.1.23. PGC

Abbreviation for Point of Generator Connection. For a more detailed description, see 3.2.23.

### 3.1.24. POC

Abbreviation for Point of Connection. POC is defined in section 3.2.38.

### 3.1.25. PWHD

Abbreviation for Partial Weighted Harmonic Distortion. For a more detailed description, see 3.2.47.

### 3.1.26. $Q_n$

$Q_n$  denotes nominal reactive power. For a more detailed description, see 3.2.40.

**3.1.27.  $S_i$** 

$S_i$  denotes apparent power of power-generating unit no.  $i$ .

**3.1.28.  $S_k$** 

$S_k$  denotes short-circuit power. For a more detailed description, see 3.2.33.

**3.1.29.  $S_n$** 

$S_n$  denotes nominal apparent power. For a more detailed description, see 3.2.43.

**3.1.30. SCR**

Abbreviation for Short-Circuit Ratio. For a more detailed description, see 3.2.35.

**3.1.31. THD**

Abbreviation for Total Harmonic Distortion. For a more detailed description, see 3.2.64.

**3.1.32.  $U_c$** 

$U_c$  denotes normal operating voltage. For a more detailed description, see 3.2.44.

**3.1.33.  $U_h$** 

$U_h$  denotes individual harmonic voltages, where  $h$  denotes the harmonic order.

**3.1.34.  $U_n$** 

$U_n$  denotes nominal voltage. For a more detailed description, see 3.2.41.

**3.1.35. UTC**

Abbreviation for Universal Time, Coordinated.

**3.1.36.  $Z_{net,h}$** 

$Z_{net,h}$  denotes grid impedance of the harmonic order  $h$ .

**3.2. DEFINITIONS****3.2.1. Absolute power limit**

A control function which limits a plant's supply of active power into the public electricity supply grid. This limit can be specified with a set point. The control function is described in detail in section 5.3.2.1.

**3.2.2. Plant owner**

The legal owner of a power-generating plant. In some contexts, the term 'company' is used instead of 'plant owner'. The plant owner can transfer the operational responsibility to a plant operator.

**3.2.3. Power-generating plant types**

In this document, the requirements are divided into different plant types based on the total size of the power-generating plant at the Point of Connection (POC). An overview of the types in relation to their total active power capacity is included in table 3.1 below.

Type A	Type B	Type C	Type D
<125 kW	≥ 125 kW and < 3 MW	≥ 3 MW and < 25MW	≥ 25 MW

Table 3.1 – Power-generating plant types.

#### 3.2.4. Plant operator

The company which has the operational responsibility for the power-generating plant through ownership or contractual obligation.

#### 3.2.5. Automatic Power Factor control

A control function for reactive power, where the Power Factor is adjusted according to a set point, and where the set point for the Power Factor varies as a function of active power. The control function is described in detail in sections 4.4.3 and 5.4.3.

#### 3.2.6. DC content

A DC current which results in an AC offset, meaning that the AC current is asymmetric around zero at the Point of Connection (POC).

#### 3.2.7. Design power ( $P_d$ )

The maximum active power a power-generating plant can supply while also supplying nominal reactive power.

#### 3.2.8. Directly connected power-generating plant

A directly connected power-generating plant is an induction generator, which is connected directly to the public electricity supply grid without other equipment (e.g. an inverter) between the generator and the public electricity supply grid.

#### 3.2.9. Power Factor (PF)

The Power Factor,  $\cos \varphi$ , for AC systems indicates the relationship between the active power  $P$  and the apparent power  $S$ , where  $P = S \cdot \cos \varphi$ . Similarly, the reactive power is  $Q = S \cdot \sin \varphi$ . The angle between current and voltage is denoted by  $\phi$ .

#### 3.2.10. Power Factor control

A control function for reactive power, where the Power Factor is adjusted according to a set point, and the Power Factor set point is fixed. The control function is described in detail in sections 4.4.2 and 5.4.2.

#### 3.2.11. Distribution system operator (DSO)

The company who owns the grid a power-generating plant is electrically connected to. Responsibilities in the public electricity supply grid are distributed among several DSOs and one transmission system operator.

The DSO is the company licensed to operate the public electricity supply grid **up to** 100 kV.

The transmission system operator is the company licensed to operate the public electricity supply grid **above** 100 kV.

### **3.2.12. Power park module**

A power-generating unit or a collection of power-generating units producing electricity which are not synchronously connected to the public electricity supply grid. Thus, all power-generating plants which are not synchronous power-generating plants constitute power park modules.

### **3.2.13. Power-generating unit**

A source of electrical energy which is connected to the public electricity supply grid.

### **3.2.14. Flicker**

A visual perception of light flickering caused by voltage fluctuations. Flicker occurs if the luminance or the spectral distribution of light fluctuates with time. At a certain intensity, flicker becomes an irritant to the eye.

### **3.2.15. Distortions in the 2-9 kHz frequency range**

Distortions in the 2-9 kHz frequency range can be found in the public electricity supply grid. Such frequencies may interfere with other customers. Interference with other customers typically occurs when emissions in this frequency range interfere with one or more resonant frequencies in the public electricity supply grid.

### **3.2.16. Disconnect**

When a power-generating plant breaks the electrical connection to the public electricity supply grid.

### **3.2.17. Frequency**

Frequency is measured in Hertz (Hz). The grid frequency in the public electricity supply grid is 50 Hz. There are also other frequencies related to power quality. Such frequencies are referred to as harmonics, interharmonic overtones and distortions in the 2-9 kHz frequency range. In connection with power quality, grid frequency is referred to as the fundamental frequency.

### **3.2.18. Frequency deviation**

When the grid frequency is outside the normal operating range.

### **3.2.19. Power response to overfrequency (LFSM-O)**

A control function for active power which automatically reduces active power as a function of the grid frequency in order to stabilise the grid frequency. Downward regulation is initiated when the grid frequency exceeds  $f_{RO}$ . The control function is described in detail in sections 4.3.1 and 5.3.1

In the RfG, this type of control is called LFSM-O (limited frequency sensitive mode at overfrequency).

### 3.2.20. Frequency response droop

The percentage frequency change which will cause an active power change corresponding to the nominal active power of the power-generating plant.

Formula for frequency response droop:

$$droop [\%] = 100 \cdot \frac{|f - f_{RO}|}{f_n} \cdot \frac{P_n}{|\Delta P|}$$

### 3.2.21. Frequency change

A change of frequency, ROCOF or df/dt, is a change of the grid frequency in the public electricity supply grid over a period of time.

The frequency change is calculated according to the following or equivalent principle.

The frequency measurement used to calculate the frequency change is based on a 200 ms measuring period where the mean value is calculated.

Frequency measurements must be made continuously, calculating a new value every 20 ms.

ROCOF [Hz/s] must be calculated as the difference between the currently performed frequency mean value calculation and the calculation performed 20 ms earlier.

(df/dt = (mean value 2 – mean value 1)/0.020 [Hz/s]).

### 3.2.22. Generator convention

These requirements apply the generator convention as shown in figure 3.1.

The sign for active/reactive power indicates the power flow as seen from the generator. Consumption/import of active/reactive power is stated with a negative sign, while the generation/export of active/reactive power is stated with a positive sign.

The desired Power Factor control is effected with a Power Factor set point, and the sign determines if control is to be performed in the first or the fourth quadrant.

Power Factor set points thus combine two pieces of information in a single signal: a set point value and choice of control quadrant.

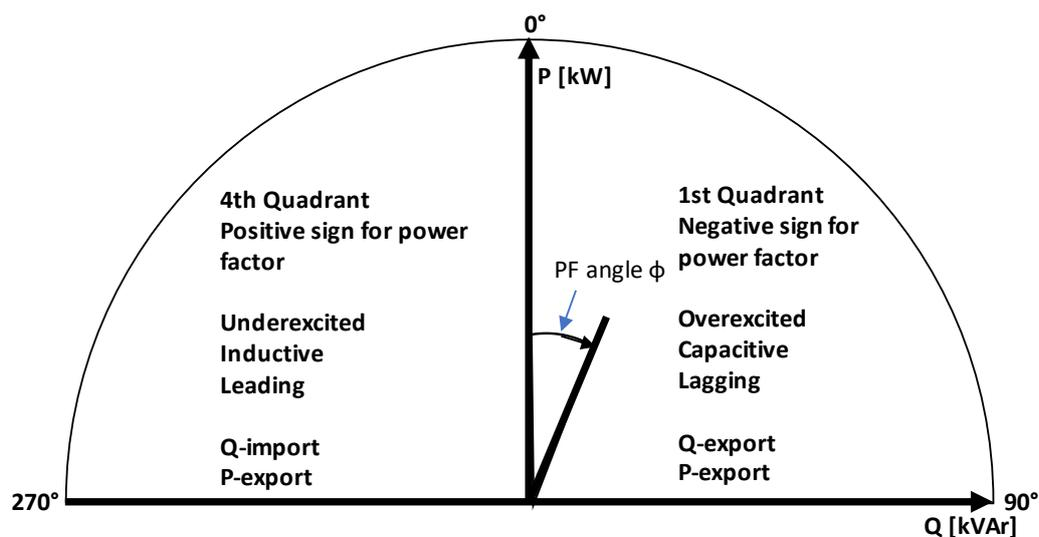

Figure 3.1 – Definition of sign for active and reactive power, Power Factor and reference for Power Factor angle.

### 3.2.23. Point of Generator Connection (PGC)

The point in the power-generating plant where the terminals for the power-generating unit are located. The power-generating unit's Point of Generator Connection (PGC) is the point which the manufacturer defines as being the power-generating unit's terminals. See figure 3.3 and figure 3.4.

### 3.2.24. Reconnection

Connecting after an event where the power-generating plant has been disconnected from the public electricity supply grid.

### 3.2.25. Ramp rate limit

A control function for active power limiting the maximum increase/reduction over time (gradient) of the active power. The control function is described in detail in section 5.3.2.2.

### 3.2.26. Harmonics

Electrical disturbances caused by harmonic currents or voltages. Harmonics are frequencies which are a whole multiple (h) of the fundamental frequency (50 Hz).

### 3.2.27. Rapid voltage change

A transient isolated change of the RMS voltage. A rapid voltage change is expressed as a percentage of the normal operating voltage.

### 3.2.28. Connection

When a power-generating plant is electrically connected to the public electricity supply grid, thereby becoming energised from the public electricity supply grid.

### 3.2.29. Point of Connection in Installation (PCI)

The point in the installation where power-generating units are connected or can be connected, see figure 3.3 for typical location.

### 3.2.30. Interharmonic overtones

Electrical disturbances caused by interharmonic currents or voltages. Interharmonic overtones are frequencies that are not a whole multiple of the fundamental frequency (50 Hz). These frequencies are located between the harmonics.

### 3.2.31. The public electricity supply grid

Publicly regulated transmission and distribution grids operated with the purpose of transporting electricity between suppliers and consumers of electricity.

The distribution grid is defined as the public electricity supply grid with a nominal voltage **below** 100 kV.

The transmission grid is defined as the public electricity supply grid with a nominal voltage **above** 100 kV.

### 3.2.32. Point of Communication (PCOM)

The point where information is exchanged between the power-generating plant and other actors. The information exchanged comprises signals, such as measurements, status, set points and commands.

### 3.2.33. Short-circuit power ( $S_k$ )

The magnitude of the three-phase short-circuit power at the Point of Connection (POC).

### 3.2.34. Short-circuit power quality ( $S_{k,powerquality}$ )

The magnitude of the three-phase short-circuit power at the Point of Connection (POC), which is used to calculate power quality.

### 3.2.35. Short-Circuit Ratio (SCR)

The relationship between the short-circuit power at the Point of Connection (POC)  $S_{k,powerquality}$  and the power-generating plant's nominal apparent power  $S_n$ .

$$SCR = \frac{S_{k,powerquality}}{S_n}$$

### 3.2.36. Point of Common Coupling (PCC)

The point in the public electricity supply grid where consumers are or can be connected.

Electrically speaking, the Point of Common Coupling and the Point of Connection (POC) may coincide. The Point of Common Coupling (PCC) is always the point deepest inside the public electricity supply grid, i.e. furthest away from the power-generating plant, see figure 3.3 and figure 3.4.

The DSO determines the Point of Common Coupling (PCC).

### 3.2.37. Excitation system

An excitation system is a system in synchronous power-generating plants which delivers a constant voltage at a selectable reference point at the Point of Connection (POC), see figure 3.2 .

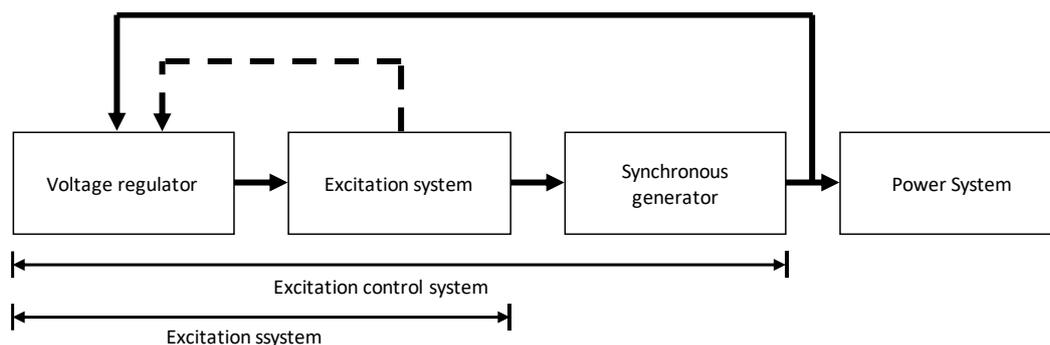

Figure 3.2 – Excitation system for synchronous generator.

### 3.2.38. Point of Connection (POC)

The point in the public electricity supply grid where a power-generating plant is or can be connected, see figure 3.3 and figure 3.4 for typical locations.

All requirements specified in this document apply to the Point of Connection (POC), unless otherwise specified.

Power-generating plants which have the same Point of Common Coupling (PCC) and the same owner are deemed to be one plant.

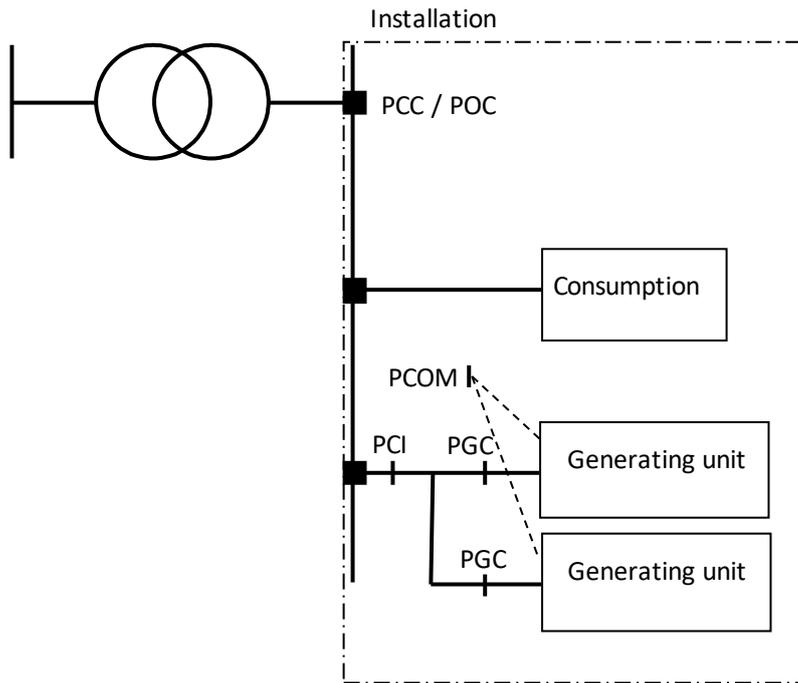

Figure 3.3 – Installation-connected generation with indication of the PGC, PCI, POC and PCC.

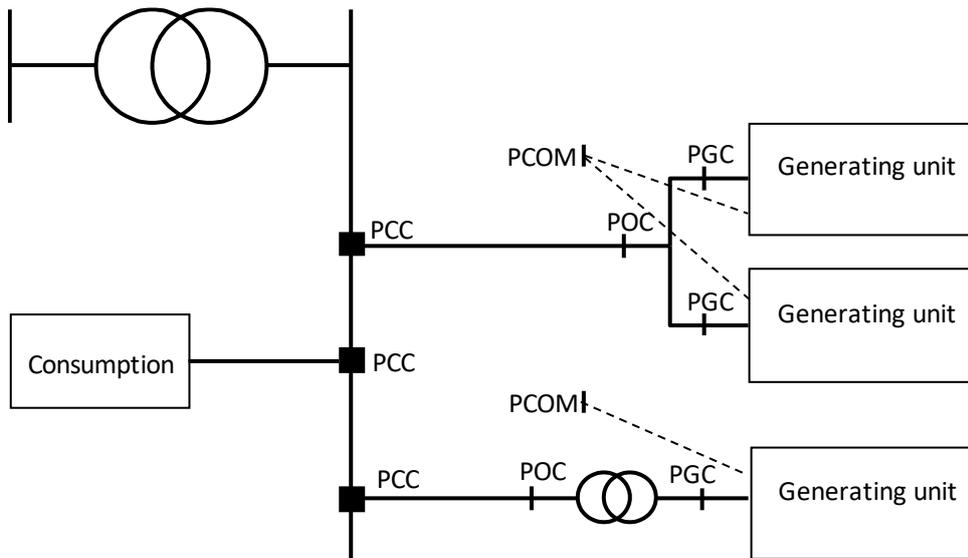

Figure 3.4 – Grid-connected generation with indication of the PGC, POC, PCC and PCOM.

figure 3.3 shows a typical installation connection of one or more power-generating plants with indication of the typical locations of Point of Generator Connection (PGC), Point of Connection (POC), Point of Connection in Installation (PCI) and Point of Common Coupling (PCC). In the illustrated example, the Point of Common Coupling (PCC) coincides with the Point of Connection (POC).

**3.2.39. Nominal active power/rated power ( $P_n$ )**

The highest level of active power that the power-generating plant is designed to continuously supply at the Point of Connection (POC). The rated power or nominal active power is denoted by  $P_n$ .

**3.2.40. Nominal reactive power ( $Q_n$ )**

The highest level of reactive power that the power-generating plant is designed to continuously supply at the Point of Connection (POC). Nominal reactive power is denoted by  $Q_n$ .

**3.2.41. Nominal voltage ( $U_n$ )**

The voltage of a grid or component. The voltage is stated phase-to-phase for three-wire systems and phase-to-neutral for four-wire systems. Nominal voltage is denoted by  $U_n$ .

**3.2.42. Nominal current/rated current ( $I_n$ )**

The maximum continuous current at the Point of Connection (POC) that a power-generating plant is designed to continuously supply under normal operating conditions, see DS/CLC/TS 50549-1:2015 and DS/CLC/TS 50549-2:2015. Rated current is denoted by  $I_n$ .

**3.2.43. Nominal apparent power ( $S_n$ )**

The highest level of power consisting of both active and reactive components that a power-generating plant is designed to continuously supply at the Point of Connection (POC). Nominal apparent power is denoted by  $S_n$ .

**3.2.44. Normal operating voltage ( $U_c$ )**

The voltage at which the grid is operated, and therefore the voltage that can be expected at the Point of Connection (POC). Normal operating voltage is denoted by  $U_c$ .

Normal operating voltage is determined by the DSO and is used to determine the normal operating range and protection. For low voltage grids, the normal operating voltage is equal to the nominal voltage.

**3.2.45. Normal operation**

The voltage and frequency range within which a power-generating plant must be capable of continuous generation. For further information about normal operation, see sections 4.1.1 and 5.1.1.

**3.2.46. Back-up power unit**

A system installed to supply emergency power to an installation, and which is not intended for operation in parallel with the public electricity supply grid.

### 3.2.47. Partial weighted harmonic distortion (PWHD)

Square sum of the total harmonic distortion from a limited group of the higher harmonic orders ( $Y_h$ ), weighted according to the individual order of harmonics ( $h$ ). PWHD is calculated from and including the 14th harmonic order ( $h = 14$ ) up to and including the 40th harmonic order ( $h = 40$ ), calculated as a percentage of the fundamental frequency ( $h = 1$ ).

$$PWHD_Y = \sqrt{\sum_{h=14}^{h=40} h \cdot \left(\frac{Y_h}{Y_1}\right)^2}$$

Where Y is either RMS currents (PWHD<sub>I</sub>) or RMS voltages (PWHD<sub>U</sub>).

### 3.2.48. The positive list

One or more lists of power-generating plant models up to 125 kW, which are deemed to comply with the requirements in this document. The lists are intended to facilitate the documentation process for grid connection of small power-generating plants for DSOs and other actors.

### 3.2.49. Power-generating plants

General term covering both synchronous power-generating plants and power park modules.

This designation is used when requirements apply to both synchronous power-generating plants and power park modules.

### 3.2.50. Q control

A control function for reactive power which controls the reactive power independently of the active power generated.

### 3.2.51. Reactive power

The imaginary component of the apparent power, usually expressed in VAR or kVAR.

### 3.2.52. Fast fault current ( $I_Q$ )

Fast fault current used to counteract voltage dips during faults in the public electricity supply grid.

### 3.2.53. Tolerance

Tolerance of voltage and frequency deviations to ensure that a power-generating plant does not disconnect from the public electricity supply grid, but instead maintains some form of operation to support the public electricity supply grid.

### 3.2.54. Signal

A measurement, status, set point or command which is exchanged between the power-generating plant and the DSO via the PCOM.

**3.2.55. Voltage dip**

Transient voltage change resulting in the effective value of the voltage at the Point of Connection (POC) being between 5% and 90% of normal operating voltage.

**3.2.56. Voltage level**

For the purpose of these requirements, the voltage levels in the distribution and transmission grids are defined according to the standard DS/EN/IEC 60038 and are as follows:

Designation of voltage level	Nominal voltage $U_n$ [kV]	System operator
Extra high voltage (EHV)	400	Transmission system operator
	220	
High voltage (HV)	150	
	132	
	60	Distribution system operator
Medium voltage (MV)	50	
	33	
	30	
	20	
	15	
Low voltage (LV)	10	
	0.4	
	0.23	

Table 3.2 – Definition of voltage levels.

**3.2.57. Voltage control**

A control function for reactive power regulating the reactive power by means of droop control for the purpose of obtaining the desired voltage at the voltage reference point.

**3.2.58. Voltage droop**

The percentage voltage change which will cause a reactive power change corresponding to the nominal reactive power of the power-generating plant.

Voltage droop formula:

$$droop [\%] = 100 \cdot \frac{|\Delta U|}{U_{ref}} \cdot \frac{Q_{nom}}{|\Delta Q|}$$

### 3.2.59. Voltage unbalance

Condition in a multiphase system where the effective values of the fundamental frequency of the outer voltages and/or the angles of the successive outer voltages are not the same.

### 3.2.60. Droop

The control parameter change (e.g. frequency) in per cent which will cause a power output change corresponding to the nominal power of the power-generating plant.

See frequency and voltage droop for more information.

### 3.2.61. Current unbalance

Condition in a multiphase system where the current amplitude and/or the angles of successive phases are not the same.

### 3.2.62. Synchronous power-generating plant

A coherent power-generating unit capable of generating electrical energy in such a way that the relationship between voltage frequency, alternator speed and grid frequency is constant and thus synchronous.

### 3.2.63. Transmission system operator

Company entrusted with the overall responsibility for maintaining security of supply and ensuring the effective utilisation of an interconnected electricity supply system.

The transmission system operator in Denmark is Energinet.

### 3.2.64. Total Harmonic Distortion (THD)

Square sum of the total harmonic distortion of the individual harmonics ( $Y_h$ ) from the second harmonic order ( $h = 2$ ) up to and including the 40th harmonic order ( $h = 40$ ), calculated as a percentage of the fundamental frequency ( $h = 1$ ).

$$THD_Y = \sqrt{\sum_{h=2}^{h=40} \left(\frac{Y_h}{Y_1}\right)^2}$$

Where Y is either RMS currents (THD<sub>I</sub>) or RMS voltages (THD<sub>U</sub>).

### 3.2.65. Abnormal operation

Operating conditions with frequency or voltage deviations – i.e. operating outside the normal operating range (see section 3.2.45).

**3.2.66. Western Denmark (DK1)**

The part of the continental European synchronous area covering Denmark west of the Great Belt.

**3.2.67. Islanding**

An operating situation which may occur in the distribution system where part of the distribution grid continues operating without being connected to the public electricity supply grid.

This is an undesirable operating situation, which is typically detected due to frequency change ( $df/dt$ ) or large voltage deviations. In such situations, the grid protection must automatically disconnect the power-generating plant from the grid.

**3.2.68. Eastern Denmark (DK2)**

The part of the northern European synchronous area covering Denmark east of the Great Belt.

## 4. REQUIREMENTS FOR TYPE A POWER-GENERATING PLANTS

### 4.1. TOLERANCE OF FREQUENCY AND VOLTAGE DEVIATIONS

A power-generating plant must comply with the following requirements for normal operation and abnormal operation.

#### 4.1.1. Normal operation

A power-generating plant must be capable of continuous generation in the 49.0 Hz-51.0 Hz frequency range.

$U_n$  at the Point of Connection (POC) is 230 V.

A power-generating plant must be capable of continuous generation when the voltage at the Point of Connection (POC) is within the 85% to 110% range of nominal voltage.

A power-generating plant must maintain operation at different frequencies for the minimum time periods specified in figure 4.1 without disconnecting from the grid.

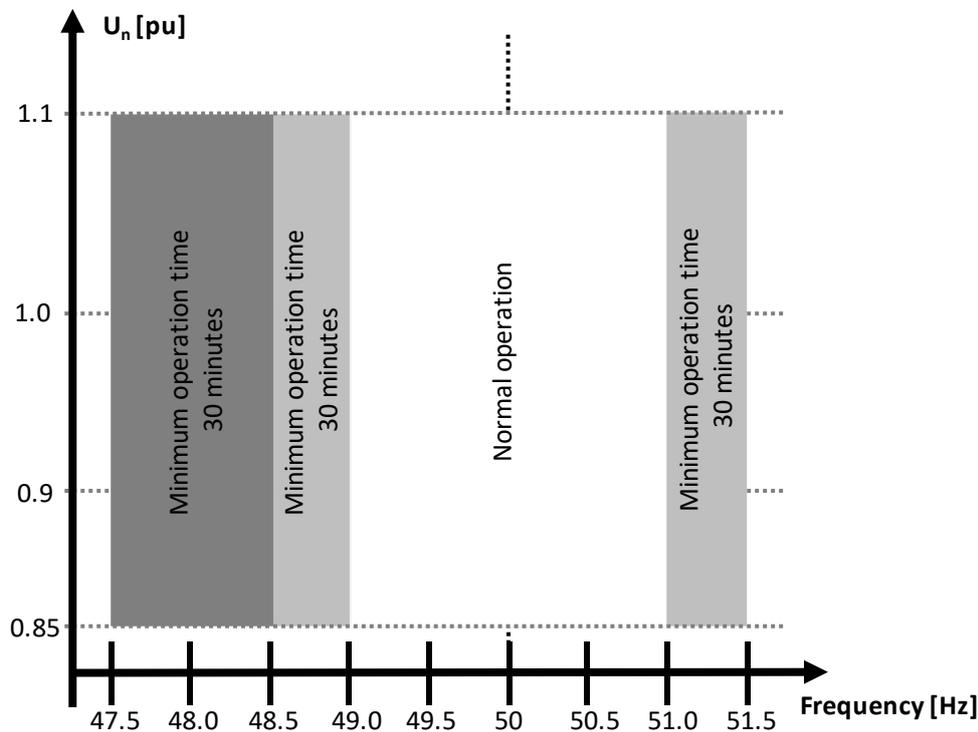

Figure 4.1 – Minimum time periods during which a power-generating plant must be capable of maintaining operation at different frequencies without disconnecting from the grid.

A power-generating plant must be designed to withstand transient voltage phase jumps of up to 20 degrees at the Point of Connection (POC) without disconnecting.

**4.1.2. Tolerance of frequency deviations**

The power-generating plant must be capable of maintaining operation in case of frequency deviations for the time periods specified in figure 4.1 without disconnecting from the public electricity supply grid.

**4.1.2.1. Frequency change**

A power-generating plant must be capable of continuous generation when frequency changes up to 2.0 Hz/s.

**4.1.2.2. Permitted reduction of active power during underfrequency**

A power-generating plant is permitted to reduce the active power within the 49 Hz-47.5 Hz frequency range. In this range, it is permitted to reduce the active power by 6% of  $P_n$ /Hz as shown in figure 4.2.

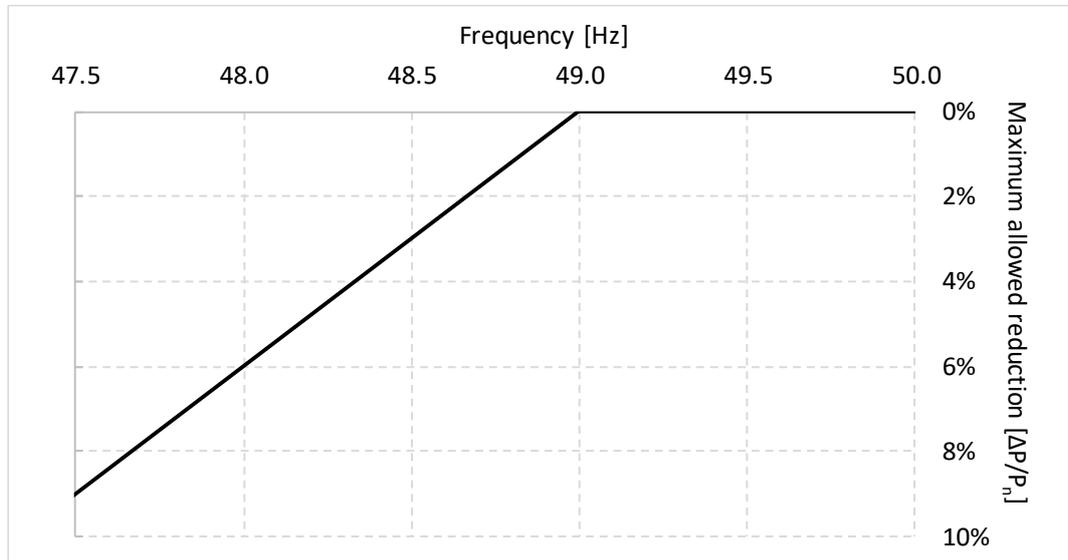

Figure 4.2 – Permitted reduction of active power during underfrequency.

Permitted reduction of active power	
Frequency range	49 Hz - 47.5 Hz
Reduction of $P_n$ /Hz	6%

Table 4.1 – Permitted reduction of active power during underfrequency.

A power-generating plant may only reduce the active power if the power-generating plant is technically incapable of continuing to supply full active power at underfrequency. This applies during normal operating conditions, which are guaranteed for 90% of the time, and must occur to the best of its ability in relation to operating point and available primary energy.

**4.1.3. Tolerance of voltage deviations**

A power-generating plant must be designed to withstand voltage deviations which may occur in the Danish distribution system during normal operation and abnormal operation. To withstand means that power-generating plant and plant components must be designed in a way which ensures that voltage deviations will not permanently damage their functionality. The power-generating plant must therefore comply with the requirements for immunity, see the relevant product standards or the DS/EN 61000-6 series.

**4.1.3.1. Permitted reduction of active power at undervoltage**

When the voltage at the Point of Connection (POC) is less than 100% of nominal value, it is allowed to reduce the generation of active power to comply with the power-generating plant’s current limitation. The reduction must be as small as technically possible.

**4.2. START-UP AND RECONNECTION OF A POWER-GENERATING PLANT**

Start-up and reconnection of a power-generating plant is only permitted when frequency and voltage are within the following ranges:

	DK 1 (Western Denmark)	DK 2 (Eastern Denmark)
Frequency range	47.5 Hz - 50.2 Hz	47.5 Hz - 50.5 Hz
Voltage range	85% - 110% U <sub>n</sub>	85% - 110% U <sub>n</sub>
Observation time	Three minutes	Three minutes

Table 4.2 – Criteria for start-up and reconnection of a power-generating plant.

After connecting a power-generating plant, the maximum active power increase per minute is 20% of nominal power.

**4.2.1. Synchronisation**

A power-generating plant must be capable of automatically synchronising to the public electricity supply grid. It must not be possible to manually circumvent the automatic synchronisation and allow the power-generating plant to connect without synchronisation.

**4.3. ACTIVE POWER CONTROL**

**4.3.1. Power response to overfrequency (LFSM-O)**

A power-generating plant must be capable of downward regulation of its active power during overfrequency. Downward regulation of active power must be initiated within two seconds at the Point of Connection (POC).

To be able to detect islanding, downward regulation of the active power at the Point of Connection (POC) must not be initiated until after 500 ms.

*If the plant's natural delay (recovery time) for commencement of downward regulation is 500 ms or more, the requirement for delay is met.*

*If the plant's natural delay (recovery time) for commencement of downward regulation is less than 500 ms, the delay must be extended to 500 ms. The additional delay is only imposed when transitioning to frequency response, i.e. when the frequency threshold  $f_{RO}$  is crossed.*

**Example**

*A plant's natural delay (recovery time) for commencement of downward regulation is 300 ms. An additional artificial delay (recovery time) of 200 ms is added to make the total delay (recovery time) for the plant 500 ms.*

The downward regulation of active power must be initiated at a frequency threshold ( $f_{RO}$ ) and follow a droop as indicated in figure 4.3, regardless of whether the frequency increases or decreases.

When a power-generating plant's lower limit for active power is reached in connection with the downward regulation, the power-generating plant must keep this minimum level of active power until the grid frequency drops again or until the plant is disconnected for other reasons.

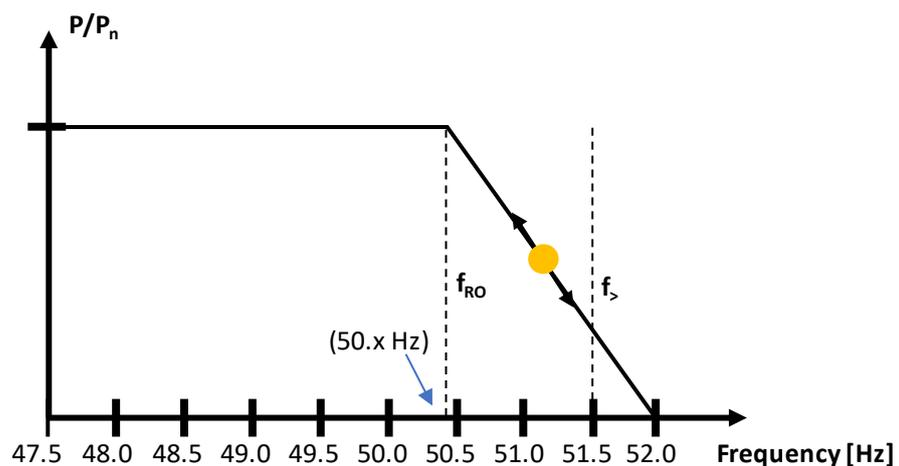

Figure 4.3 – Frequency response droop to overfrequency.

The frequency threshold for commencement of frequency response must be set in the 50.2 Hz - 50.5 Hz frequency range, both values inclusive, with a resolution of 10 mHz or better.

## Requirements for type A power-generating plants

---

The droop of the active power reduction must be in the 2-12% range with a resolution of 1% or better.

The settings for frequency response to overfrequency for Western and Eastern Denmark are as follows:

	DK 1 (Western Denmark)	DK 2 (Eastern Denmark)
Frequency threshold $f_{RO}$	50.2 Hz	50.5 Hz
Droop	5%	4%
Delay for islanding detection	500 ms	500 ms

Table 4.3 – Default settings for frequency response – overfrequency for DK1 and DK2.

When the frequency response is enabled, the active power must follow the droop with a deviation of 5% of nominal active power or better, measured over a period of one minute.

Frequency must be measured with an accuracy of  $\pm 10$  mHz or better.

### 4.4. REACTIVE POWER CONTROL

A power-generating plant must be capable of controlling its supply of reactive power. Only one of the following required control functions can be active at a time.

The power-generating plant must be capable of controlling its reactive power using the functions and characteristics described in sections 4.4.2 to 4.4.4. It must be possible to indicate set points in steps of 1% of  $S_n$  or better for power and 0.01 or better for Power Factor.

Control must be performed with an accuracy of  $\pm 2\%$  of the power-generating plant's nominal apparent power. The control accuracy is measured over a period of one minute.

The control accuracy may be worse than  $\pm 2\%$  of  $S_n$  when active power generation is below 10% of power-generating plant nominal apparent power. However, the exchange of uncontrolled reactive power must never be greater than 10% of power-generating plant nominal apparent power.

When one or more power park modules of a power-generating plant are taken out of operation for scheduled maintenance, the plant's supply of reactive power may be reduced proportionately to the number of power park modules taken out of operation.

**4.4.1. Reactive power range**

The ability to supply reactive power (operating range) depends on the type of power-generating plant. When a power-generating plant is to supply or consume reactive power, it is allowed to reduce the generation of active power in order to comply with the plant nominal apparent power. The reduction must be as small as technically possible.

**4.4.1.1. (a) A synchronous power-generating plant**

A synchronous power-generating plant must be capable of supplying reactive power at different voltages at the Point of Generator Connection (PGC) as specified in figure 4.4.

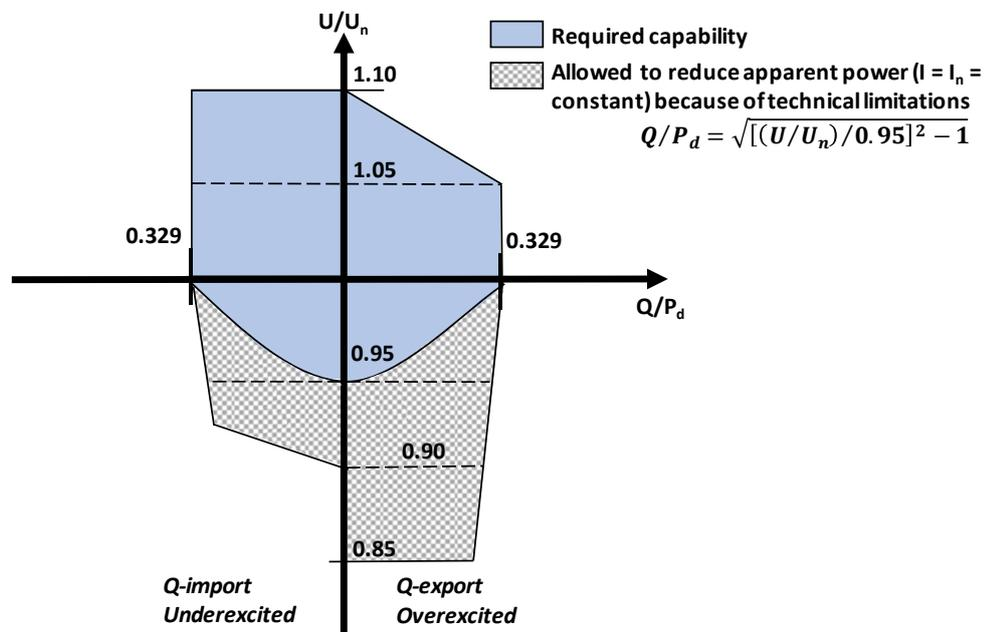

Figure 4.4 – Requirements for supply of reactive power at different voltages at the Point of Generator Connection (PGC).

A synchronous power-generating plant must be capable of supplying reactive power at different active power levels as specified in figure 4.5.

For synchronous power-generating plants where  $P_d$  is less than  $P_n$ , operation within the 'design freedom' range is allowed. The power-generating plant must not supply active power greater than  $P_n$ .

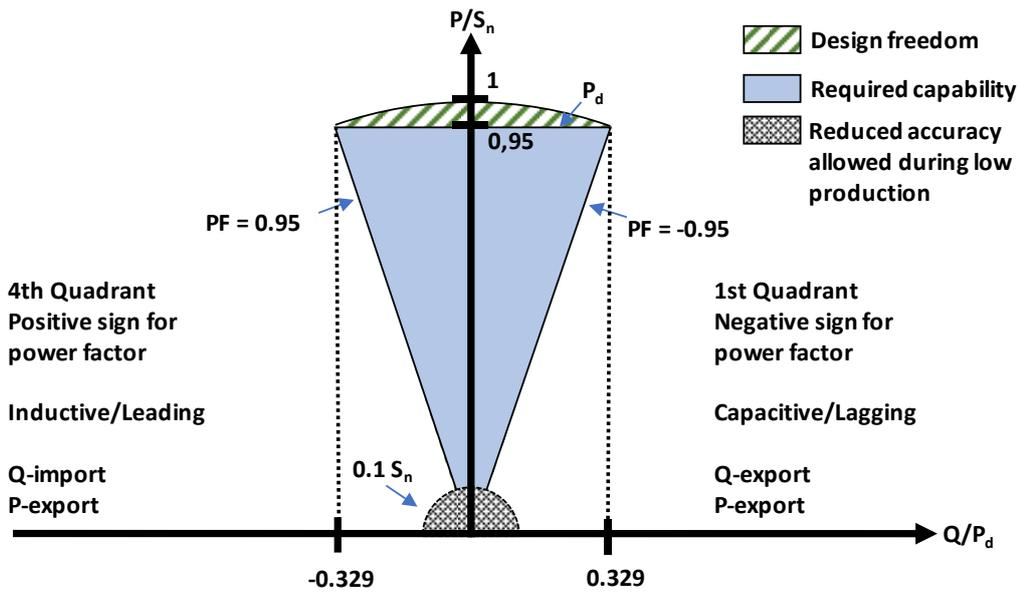

Figure 4.5 – Requirements for supply of reactive power at different active power levels.

Outside the ranges described in figure 4.4 and figure 4.5, a synchronous power-generating plant must supply stable reactive power in accordance with the selected control mode, which may only be limited by the technical performance of the plant, e.g. saturation or undercompensation.

4.4.1.2. (b) A power park module

A power park module must be capable of supplying reactive power at different voltages at the Point of Generator Connection (PGC) as specified in figure 4.6.

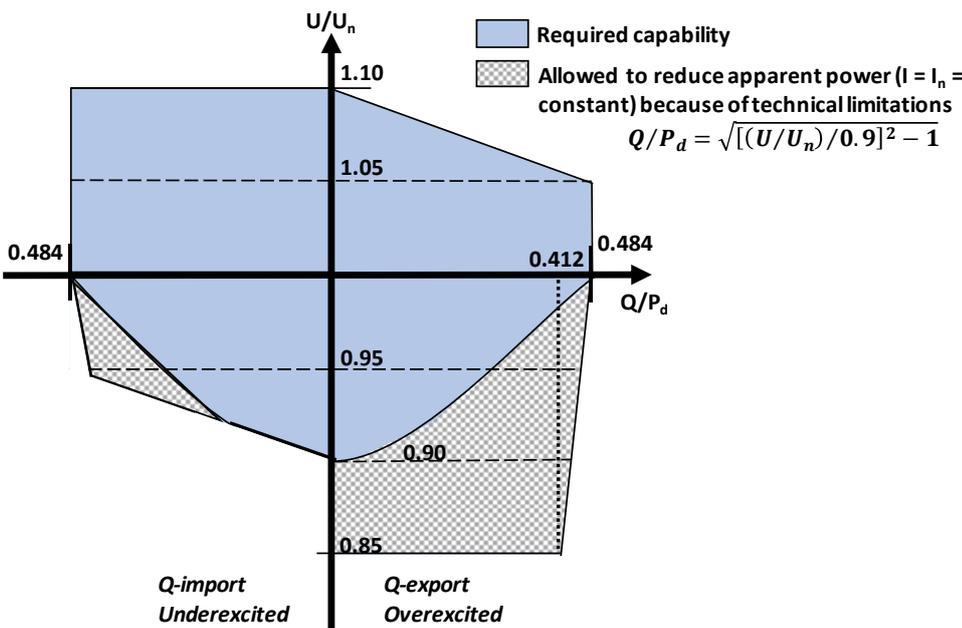

Figure 4.6 – Requirements for supply of reactive power at different voltages at the Point of Generator Connection (PGC).

A power park module must be capable of supplying reactive power at different active power levels as specified in figure 4.7.

For power park modules where  $P_d$  is less than  $P_n$ , operating within the ‘design freedom’ area is allowed. The plant must not supply active power greater than  $P_n$ .

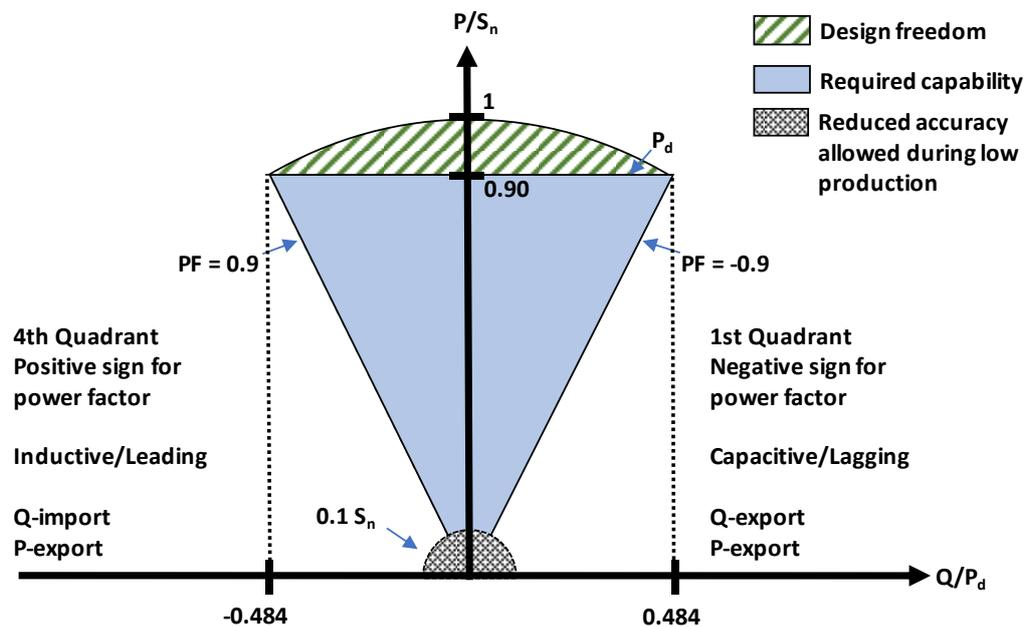

Figure 4.7 – Requirements for supply of reactive power at different active power levels.

Outside the ranges described in figure 4.6 and figure 4.7, a power park module must supply stable reactive power in accordance with the selected control mode, which may only be limited by the technical performance of the unit, e.g. saturation or undercompensation.

### Directly connected power-generating plants

Directly connected power-generating plants that cannot control the reactive power are exempt from the general requirements for reactive power control.

For directly connected power-generating plants up to and including 11 kW, the plant is required to produce at a Power Factor of 0.95 or better.

## Requirements for type A power-generating plants

For directly connected power-generating plants larger than 11 kW, the plant is required to produce a selectable Power Factor in the range 0.95 inductive to 1. This requirement applies when producing at nominal active power. The Power Factor is agreed with the DSO.

If passive compensation is used to meet the requirement for reactive power, the compensation may only be activated when the unit is connected and in operation.

*The Power Factor is agreed with the DSO when connecting to the grid. It is thus possible to use passive correction of the Power Factor (capacitors) while the DSO is ensured a minimum of control of the reactive power from the electricity-generating plant.*

### Single-phase power park modules

Single-phase plants up to and including 3.68 kW are exempt from the requirement for control functions 'automatic Power Factor control' (section 4.4.3) and 'Q control' (section 4.4.4).

#### 4.4.2. Power Factor control

A power-generating plant must be capable of performing Power Factor control allowing the reactive power to be controlled by means of a fixed Power Factor, see figure 4.8.

When a new Power Factor set point is set, the control must be completed within one minute.

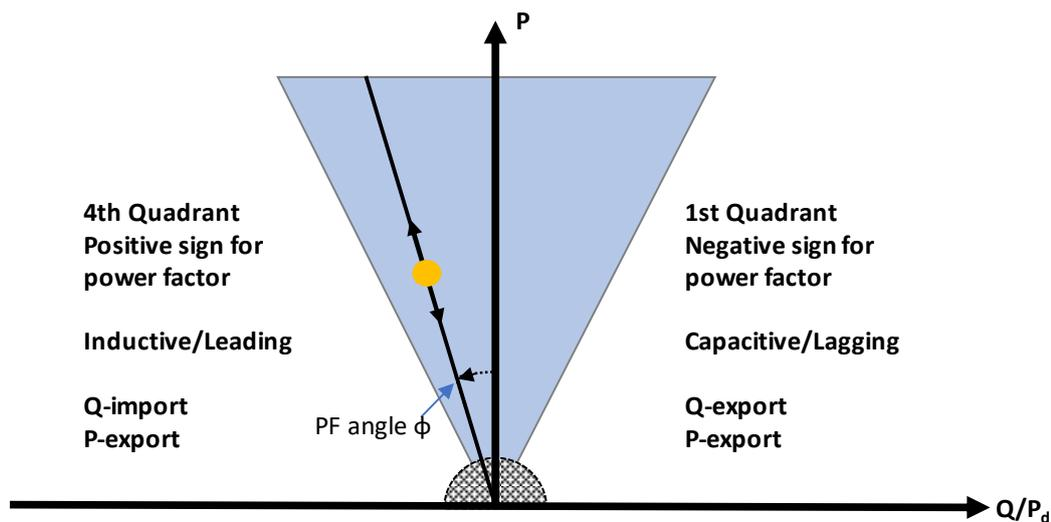

Figure 4.8 – Example of Power Factor control [ $\cos \phi$  set point].

A power-generating plant may not exchange reactive power with the public electricity supply grid unless otherwise agreed with the DSO. I.e. the plant will by default produce at a Power Factor of 1.

If the function is to be enabled, the setting values for the control function are agreed with the DSO.

### 4.4.3. Automatic Power Factor control

A power-generating plant must be capable of performing automatic Power Factor control as shown in figure 4.9.

Reactive power control must be completed within ten seconds after the active power has stabilised.

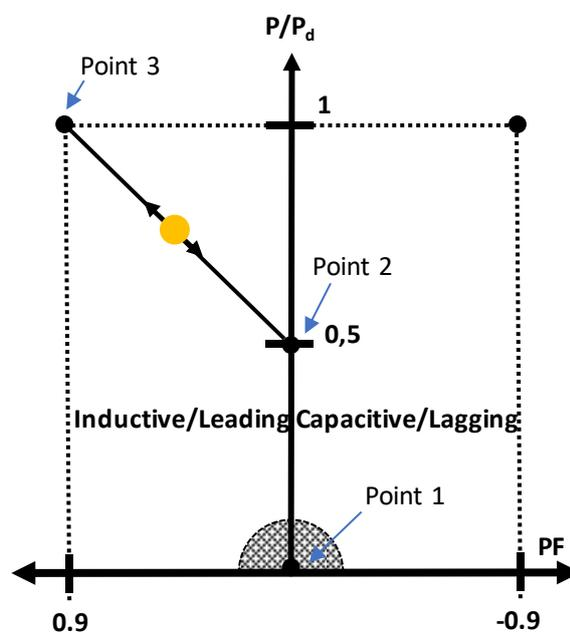

Figure 4.9 – Default setting for automatic Power Factor control [ $\cos \phi (P)$ ].

## Requirements for type A power-generating plants

Default settings for the characteristics are specified in table 4.4.

Characteristics points		
Point	P/P <sub>n</sub>	Power Factor
1	0.0	1.0
2	0.5	1.0
3	1	0.9 inductive

Table 4.4 – Characteristic points.

The function is normally activated at 105% of U<sub>n</sub> and deactivated at 100% of U<sub>n</sub>.

A power-generating plant may not exchange reactive power with the public electricity supply grid unless otherwise agreed with the DSO. I.e. the plant will by default always produce at a Power Factor of 1.

If the function is to be enabled, the setting values for the control function are agreed with the DSO.

### 4.4.4. Q control

A power-generating plant must be capable of performing Q control as shown in figure 4.10.

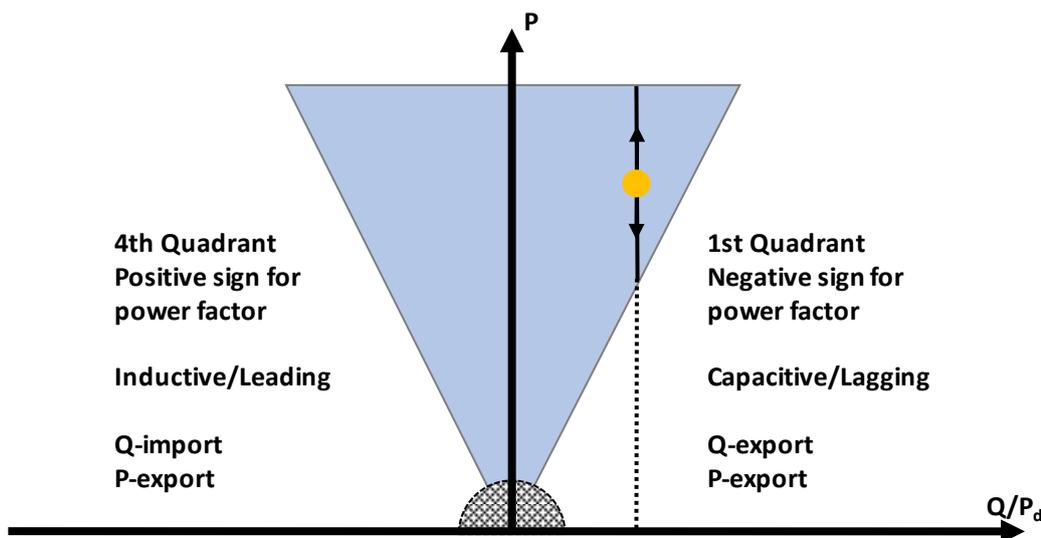

Figure 4.10 – Example of Q control [Q set point].

Control from one set point to another must be completed within one minute.

A power-generating plant may not exchange reactive power with the public electricity supply grid unless otherwise agreed with the DSO. I.e. the plant must produce by default Power Factor of 1.

If the function is to be enabled, the current setting values for the control function are agreed with the DSO.

### 4.5. PROTECTION

#### 4.5.1. General

Power-generating plant protection must both protect the plant and help ensure stability in the public electricity supply grid.

Relay settings must not prevent specified power-generating plant functions from working properly.

The power-generating plant owner is responsible for ensuring that the plant is dimensioned and equipped with the necessary protection functions so that the plant:

- Is protected against damage due to faults and incidents in the public electricity supply grid
- Protects the public electricity supply grid against unwanted impacts from the power-generating plant
- Is protected against damage as a result of asynchronous connections
- Is protected against disconnection in non-critical situations for the power-generating plant
- Is not damaged and does not switch off during voltage dips as specified in section 4.1.3.

The DSO or the transmission system operator may demand that the setting values for protection functions be changed after commissioning of the power-generating plant if it is deemed to be of importance to the operation of the public electricity supply grid.

Following disconnection of a power-generating plant due to a fault in the public electricity supply grid, the plant must not reconnect automatically earlier than specified in section 4.2.

## Requirements for type A power-generating plants

---

A power-generating plant which has been disconnected by an external signal prior to a fault occurring in the public electricity supply grid must not be connected until the external signal has been eliminated and the voltage and frequency are once again within the range specified in section 4.2.

At the plant owner's request, the DSO must state the highest and lowest short-circuit current that can be expected at the Point of Connection (POC) as well as any other information about the public electricity supply grid as may be necessary to configure the power-generating plant's protection functions.

Voltage and frequency must be measured simultaneously for the phases which the power-generating plant is connected to at the Point of Connection (POC).

### 4.5.2. Requirements for protection functions and settings

The power-generating plant's protection functions and associated settings must be as specified in the following subsections. Settings deviating from the default setting values specified in this document, e.g. in the event of problems with local overvoltages, may only be used with the DSO's permission.

In connection with internal short circuits in the power-generating plant, the relay protection must be selective with the grid protection. This means that short circuits in the power-generating plant must be disconnected within 100 ms.

All settings are stated as RMS values.

The power-generating plant must be disconnected or shut down if a measured signal deviates more from its nominal value than the setting.

The trip time stated is the measuring period during which the trip condition must constantly be fulfilled in order for the protection function to release a trip signal.

The accuracy of voltage and frequency measurements must be  $\pm 1\%$  of  $U_n$  and  $\pm 0.05$  Hz or better respectively.

The frequency change is calculated according to the following or equivalent principle.

The frequency measurement used to calculate the frequency change is based on a 200 ms measuring period where the mean value is calculated.

Frequency measurements must be made continuously, so that a new value is calculated for each 20 ms.

ROCOF must be calculated as the difference between the currently performed frequency mean value calculation and the mean value calculation performed 20 ms before.

$$(df/dt = (\text{mean value 2} - \text{mean value 1})/0.020 \text{ [Hz/s]}).$$

If a power-generating plant is isolated with part of the public electricity supply grid, the plant must not cause temporary overvoltages that can damage the plant or the public electricity supply grid.

#### 4.5.3. Requirements for grid protection

A power-generating plant must have protection functions, setting ranges and trip time intervals as specified in table 4.5. Unless otherwise agreed with the DSO, the default values in the table are to be used. The ranges and resolutions are indicative, not required.

Protection function	Symbol	Setting (Range/Resolution)		Trip time (Range/Resolution)	
Overvoltage (step 2)	$U_{>>}$	1.0-1.3/0.01 Default: 1.15	$U_n$	0.1-5/0.05 Default: 0.2	s
Overvoltage (step 1)	$U_{>}$	1.0-1.2/0.01 Default: 1.10	$U_n$	0.1-100/0.1 Default: 60	s
Undervoltage (step 1)	$U_{<}$	0.2-1.0/0.01 Default: 0.85	$U_n$	0.1-100/0.1 Default: 50	s
Overfrequency	$f_{>}$	50.0-52.0/0.1 Default: 51.5	Hz	0.1-5/0.05 Default: 0.2	s
Underfrequency	$f_{<}$	47.0-50.0/0.1 Default: 47.5	Hz	0.1-5/0.05 Default: 0.2	s

Table 4.5 – Requirements for all power-generating plants, regardless of type.

##### 4.5.3.1. (a) Additional requirements for grid protection of synchronous power-generating plants

In addition to the general protection functions and settings, synchronous power-generating plants above 11 kW must also have the protection functions and settings specified in table 4.6.

## Requirements for type A power-generating plants

A synchronous undervoltage relay is only required when the DSO deems that there is a risk of asynchronous connection. The DSO determines the setting values for the synchronous undervoltage relay.

*The DSO to whose grid the plant is connected calculates the setting values for the synchronous undervoltage relay using the principles in the Research Association of the Danish Electric Utilities (DEFU) technical report no. 293, 3rd edition on 'Relay protection at local production with synchronous generators', March 2018.*

It is allowed to use a fuse instead of overcurrent relay (step 1). In this case, the fuse size and characteristics must be approved by the DSO.

Protection function	Symbol [IEC]	Setting			Trip time	
		Setting	Unit	Value	Unit	Value
Synchronous undervoltage*	-	Determined by the DSO	V	≤50	ms	
Overcurrent (step 2)**	$I_{>>}$	Determined by the DSO	A	50	ms	
Overcurrent (step 1)	$I_{>}$	1.2	$I_n$	2	s	

\*) If synchronous undervoltage relay is used.

Synchronous undervoltage relay: The setting is dependent on local generator and grid data. The setting is calculated by the DSO.

\*\*\*) If synchronous undervoltage relay is not used, the generator manufacturer's settings for overcurrent protection are used.

Table 4.6 – Additional protection settings for synchronous power-generating plants.

### 4.5.4. Requirements for islanding detection

A power-generating plant must be capable of detecting unintentional island operation and must disconnect from the public electricity supply grid if unintentional islanding is detected.

In Denmark, only passive islanding detection methods are used. The use of vector jump relays (ANSI 78) or active islanding detection is not allowed on power-generating plants connected to the Danish public electricity supply grid.

A power-generating plant must have at least one of the functions for islanding detection specified in table 4.7. Unless otherwise agreed with the DSO, the default values in the table are used.

Protection function	Symbol	Setting (Range/Resolution)		Trip time (Range/Resolution)	
		Undervoltage (step 2)*	$U_{\ll}$	0.2-1/0.01 Default: 0.80	$U_n$
Frequency change*	df/dt	0-3.5/0.1 Default: $\pm 2.5$	Hz/s	0-5/0.01 Default: 0.08	s

\*At least one of the functions must be used.

Table 4.7 – Requirements for islanding detection.

#### 4.5.5. Earthing

Requirements related to earthing of the power-generating plant must be agreed with the DSO.

#### 4.6. POWER QUALITY

A power-generating plant must comply with the power quality requirements specified in European standards and the requirements of this section. Different standards apply, depending on the power-generating plant's nominal power.

##### 4.6.1. Emission limits

All power-generating plants must comply with the requirements described in sections 4.6.1.1 and 4.6.1.2.

In addition, power-generating plants up to and including 11 kW must comply with the requirements of DS/EN 61000-3-2 and DS/EN 61000-3-3. These international standards cover, among other things, flicker, rapid voltage changes and harmonics.

In addition, power-generating plants above 11 kW up to and including 50 kW must comply with the requirements of DS/EN 61000-3-11 and DS/EN 61000-3-12. These international standards cover, among other things, flicker, rapid voltage changes and harmonics.

In addition, power-generating plants above 50 kW must comply with the requirements and limit values specified in sections 4.6.1.3 to 4.6.1.7. These sections cover, among other things, flicker, rapid voltage changes and harmonics.

*The limit values specified in sections 4.6.1.3 to 4.6.1.7 of these instructions are based on the Research Association of the Danish Electric Utilities (DEFU) report RA 557 and the principles in IEC/TR 61000-3-14.*

### 4.6.1.1. DC content

A power-generating plant may not inject DC currents into the grid. This requirement is met if the DC content of the current injected by the plant into the grid is below 0.5% of the nominal current of the plant.

If the power-generating plant is connected to the grid by means of a plant transformer, it is assumed that this requirement is met.

*The reason for having a limit value for DC content is that DC currents are undesirable in the public electricity supply grid and may have an adverse effect on grid operation and protection. The limit value is set based on IEC/TR 61000-3-15, which provides recommendations for requirements for local production connected to the public electricity supply grid at low-voltage level.*

*Documentation of DC content can be omitted if all units in the installation is on the positive list. If all the individual units DC content is less than 0,5% of the nominal current, then it is assumed the combined power-generating plant also complies.*

### 4.6.1.2. Current unbalance

The current unbalance between the three phases of a power-generating plant must not exceed 16 A.

Power-generating plants above 11 kW must have balanced three-phase connections, i.e. be designed to supply the same current on all three phases at the same time.

*Requirements for unbalance are made because unbalance in phase voltages and phase currents is undesirable in the public electricity supply grid as it may have an adverse effect on grid operation and the units connected to the public electricity supply grid.*

*The requirement is fixed on the basis of the Joint Regulation (Fællesregulativet) and international standards. In Denmark, it is allowed to connect single-phase units with a nominal current of up to 16 A, and many international standards use 16 A per phase as the limit value for the units covered by the standards.*

*International standards covering unbalance consider the voltage unbalance. As documenting compliance with requirements for voltage unbalance is more complicated, it has been chosen only to make requirements for current unbalance for plants connected to low voltage. It is easier to document compliance with requirements for current unbalance, among other things, because they do not depend on the short-circuit power at the Point of Connection (POC).*

#### 4.6.1.3. Rapid voltage changes

A power-generating plant must not cause rapid voltage changes exceeding the limit value specified in table 4.8.

<b>Limit value</b>
d(%) = 4%

**Table 4.8 – Limit for rapid voltage changes as a percentage of  $U_n$ .**

*Requirements for rapid voltage changes are based on DS/EN 61000-3-11 and the Research Association of the Danish Electric Utilities (DEFU) report RA 557 as well as the methods for determining limit values described in IEC/TR 61000-3-14.*

#### 4.6.1.4. Flicker

A power-generating plant must not cause flicker contributions exceeding the limits for short-term and long-term flicker as specified in table 4.9.

	Short-term flicker ( $P_{st}$ )	Long-term flicker ( $P_{lt}$ )
Limit value	0.35/0.45/0.55*	0.25/0.30/0.40*
<b>*Limits apply if 4+/2/1 power-generating plants are connected to the same substation.</b>		

**Table 4.9 – Limit value for short-term and long-term flicker.**

*Flicker limit values are based on DS/EN 61000-3-11 and the Research Association of the Danish Electric Utilities (DEFU) report RA 557 as well as the methods for determining limit values described in IEC/TR 61000-3-14.*

**4.6.1.5. Harmonics**

A power-generating plant may not emit harmonic currents exceeding the limits in table 4.10 for the individual harmonics, which are expressed as a percentage of the nominal current of the plant ( $I_h/I_n$  (%)). The limits depend on the SCR between a power-generating plant’s nominal apparent power and the short-circuit power at the plant’s Point of Connection (POC).

SCR	Odd-order harmonics h							Even-order harmonics h					
	3	5	7	9	11	13	15	2	4	6	8	10	12
<33	3.4	3.8	2.5	0.5	1.2	0.7	0.35	0.5	0.5	1.0	0.8	0.6	0.5
≥33	3.5	4.1	2.7	0.5	1.3	0.7	0.37	0.5	0.5	1.0	0.8	0.6	0.5
≥66	3.9	5.2	3.4	0.6	1.8	1.0	0.43	0.5	0.5	1.0	0.8	0.6	0.5
≥120	4.6	7.1	4.6	0.8	2.5	1.5	0.5	0.5	0.5	1.0	0.8	0.6	0.5
≥250	6.3	11.6	7.3	1.3	4.4	2.7	0.8	0.5	0.5	1.0	0.8	0.6	0.5
≥350	7.5	15.0	9.5	1.6	5.7	3.7	1.0	0.5	0.5	1.0	0.8	0.6	0.5

**Table 4.10 – Limits for harmonic currents  $I_h/I_n$  (% of  $I_n$ ).**

In addition to the limits for the individual harmonics, there are also limits for total harmonic emissions. Limits for THD<sub>i</sub> and PWHD<sub>i</sub> are specified in table 4.11.

SCR	THD <sub>i</sub>	PWHD <sub>i</sub>
<33	4.4	4.4
≥33	4.7	4.7
≥66	6.1	6.1
≥120	8.4	8.4
≥250	13.8	13.8
≥350	18.0	18.0

**Table 4.11 – Limits for THD<sub>i</sub> and PWHD<sub>i</sub> in current (%  $I_n$ ).**

The requirements for individual harmonics,  $THD_I$  and  $PWHD_I$ , are based on DS/EN 61000-3-12 Table 3 and the Research Association of the Danish Electric Utilities (DEFU) report RA 557 as well as the methods for determining limit values described in IEC/TR 61000-3-14.

The 2nd and 4th order harmonics are reduced compared to the method in RA 557, because they may indicate DC content in the current supplied to the public electricity supply grid. Exceeding the limit values for the 2nd or 4th harmonic orders may indicate that the plant does not meet the requirement for DC content.

Triplen harmonics are added based on their ratio of the limit values in DS/EN 50160. Triplen harmonics should not occur at all in balanced three-phase equipment. However, three-phase inverters have been observed to produce these harmonics at times due to the inverter control. Therefore, it has been decided to add a limit for them. In practice, the limits for triplen harmonics in these instructions have been set high enough that they should never constitute a problem in a balanced three-phase plant. If a plant exceeds these limits, this will indicate that the plant cannot be categorised as being balanced, and it can therefore not be connected, because it does not comply with the unbalance requirements.

#### 4.6.1.6. Interharmonic overtones

A power-generating plant must comply with the current emission limits specified for all interharmonic overtones as specified in table 4.12.

SCR	Frequency (Hz)		
	75 Hz	125 Hz	>175 Hz
<33	0.4	0.6	$\frac{75}{f}^*$
≥33	0.5	0.7	$\frac{83}{f}^*$
≥66	0.6	0.8	$\frac{104}{f}^*$
≥120	0.7	1.1	$\frac{139}{f}^*$
≥250	1.2	1.8	$\frac{224}{f}^*$
≥350	1.5	2.3	$\frac{289}{f}^*$

**\*However, not less than the meas-**

SCR	Frequency (Hz)		
	75 Hz	125 Hz	>175 Hz
Measurement uncertainty.			

Table 4.12 – Limits for interharmonic overtones, expressed in current (% of  $I_n$ ).

*Limits for interharmonic overtones are based on DS/EN 61000-3-12 and the Research Association of the Danish Electric Utilities (DEFU) report RA 557 as well as the methods for determining limit values described in IEC/TR 61000-3-14.*

#### 4.6.1.7. Distortions in the 2-9 kHz frequency range

A power-generating plant must comply with the current emission limits specified in table 4.13 for all 200 Hz frequency groups between 2 kHz and 9 kHz.

Limit value
0.2%

Table 4.13 – Limits in current stated as a percentage of  $I_n$  for all frequencies between 2 kHz and 9 kHz.

*Limits for distortions in the 2-9 kHz frequency range is based on the Research Association of the Danish Electric Utilities (DEFU) report RA 557.*

#### 4.6.2. Division of responsibilities

##### 4.6.2.1. The power-generating plant owner's obligations

As a rule, the power-generating plant owner must ensure that the plant is designed, constructed and configured to comply with all emission limits.

The power-generating plant owner must verify that emission limits at the Point of Connection (POC) are complied with.

For calculation of power quality, the power-generating plant owner uses the typical three-phase short-circuit power,  $S_{k, \text{powerquality}}$  at the Point of Connection (POC).

*Subject to agreement, the plant owner can buy additional services (higher short-circuit power or higher subscribed capacity) from the DSO in order to comply with the specified limit values.*

##### 4.6.2.2. The DSO's obligations

The DSO is responsible for setting emission limits at the point of connection.

The DSO must specify the short-circuit level  $S_{k, \text{powerquality}}$  with associated impedance angle  $\psi_k$  at the Point of Connection (POC).

#### 4.6.3. Measuring method

Measurements of various power quality parameters must be carried out in accordance with the European standard DS/EN 61000-4-30 (class A).

Measurement of harmonic distortion of voltage and current must be carried out as defined in IEC 61000-4-7 in accordance with the principles (harmonic subgroup) and with the accuracies specified for class I.

Measurement of interharmonic distortion up to 2 kHz must be carried out as defined in IEC 61000-4-7 Annex A and must be measured as interharmonic subgroups.

Alternatively, it is allowed to measure harmonic distortion up to 2 kHz with grouping enabled (harmonic groups) as specified in IEC 61000-4-7 and with the accuracies specified for class I. If harmonic distortion up to 2 kHz is measured with grouping enabled, it is not required to measure interharmonic distortion up to 2 kHz separately.

Measurement of distortions in the 2-9 kHz frequency range must be carried out as defined in IEC 61000-4-7 Annex B and must be measured in 200 Hz windows with centre frequencies from 2100 Hz to 8900 Hz.

#### 4.7. EXCHANGE OF INFORMATION

A power-generating plant must be equipped with a PCOM in order to be able to stop active power generation. Generation must be stopped no later than five seconds after the stop command has been received.

Signal description	Signal type
Stop signal	Command
Hold signal – ‘Released for start’	Command

Table 4.14 – Table of signals to be made available in the PCOM interface.

A power-generating plant may start production when the reconnection criteria are met, see section 4.2, and the ‘Released for start’ signal has been received.

*Exchange of information can be performed via a terminal block or via an RTU, subject to agreement with the DSO.*

### 4.8. VERIFICATION AND DOCUMENTATION

This section describes the documentation to be provided by the power-generating plant owner or a third party to the DSO in order to obtain operational notification.

The power-generating plant owner is responsible for complying with the requirements described in this document and for documenting such compliance.

The DSO may at any time request verification and documentation showing that the power-generating plant meets the requirements described in this document.

#### 4.8.1. Documentation requirements

If a power-generating plant is not on the positive list or is larger than 50 kW, the following documentation must be submitted to the DSO:

- CE Declaration of Conformity
- Protection function settings
- Power quality
- Annexes B1.1 and B1.2 complete with technical documentation in support of the answers given.

Product certificates issued by an approved certification body may also be used. The product certificates may cover some of the documentation requirements.

#### 4.8.2. Documentation requirements (when on the positive list)

When a power-generating plant is on the positive list, Annex B1.1 must be submitted to the DSO before commissioning.

- Annex B1.1 complete with settings for power-generating plant control functions and protection.

If all power-generating units in a power-generating plant, which are over 50 kW and up to 125 kW, are on the positive list, the following documentation must be submitted to the DSO:

- Power quality (Calculation)
- Annex B1.1 complete with settings for power-generating plant control functions and protection

*The positive list is a list of plants up to 125 kW, which are deemed to comply with the requirements of these instructions. As the plants have already been assessed in advance, the documentation requirements for the plant owner or a third party are less comprehensive towards the DSO.*

*Power-generating plants up to and including 50 kW, that consists of multiple units from the positive list, are considered to be in compliance with the power quality requirements.*

*If a Inverter over 50kW and up to 125 kW, can document power quality based on (worst case) requirements in section 4.6, then it can become completely pre-approved. Documentation of power quality will always be necessary in case of an installation over 50 kW and up to 125 kW consisting of more than one invert-*

### 4.8.3. Inclusion on the positive list

In order to be included on the positive list, the following documentation must be submitted to [positivlister@greenpowerdenmark.dk](mailto:positivlister@greenpowerdenmark.dk).

- CE Declaration of Conformity
- Default protection function settings
- Power quality
- Annex B1.2 complete with technical documentation in support of the answers given.

Product certificates issued by an approved certification body may also be used. The product certificates may cover some of the documentation requirements.

For further information and guidance, please refer to <https://greenpowerdenmark.dk/vejledning-teknik/positivlister>.

### ***CE Declaration of Conformity***

*CE Declarations of Conformity must be submitted for each of the main components. For a single plant, the CE Declaration of Conformity must be submitted for the plant. The CE Declaration of Conformity must contain a list of relevant standards, codes of practice and directives which the component or plant complies with.*

### ***Power quality***

*Power quality is a collection of parameters characterising the electricity supplied. A certificate or report demonstrating that the requirements are complied with must be presented.*

*For plants above 50 kW, power quality calculation must be performed, showing that emissions from the plant are below the limits specified in section 4.6. The power quality calculation must be submitted with Annex B1.2.*

### ***Completion of annexes***

*A completed Annex B1.2 means that the annex in these instructions must be completed, and that technical documentation verifying the correctness of the answers given in the annex is attached. Technical documentation may include a test report, product certificate, user manual, simulations, tests, etc.*

*If the plant is included on the positive list, it is sufficient for a plant owner to complete Annex B1.1 without attaching further technical documentation.*

## 5. REQUIREMENTS FOR TYPE B POWER-GENERATING PLANTS

### 5.1. IMMUNITY TO FREQUENCY AND VOLTAGE DEVIATIONS

#### 5.1.1. Normal operation

A power-generating plant must be capable of continuous generation in the 49.0 Hz-51.0 Hz frequency range.

$U_n$  at the Point of Connection (POC) is 230 V.

A power-generating plant must be capable of continuous generation when the voltage at the Point of Connection (POC) is within the 85% to 110% range of nominal voltage.

A power-generating plant must maintain operation at different frequencies for the minimum time periods specified in figure 5.1 without disconnecting from the grid.

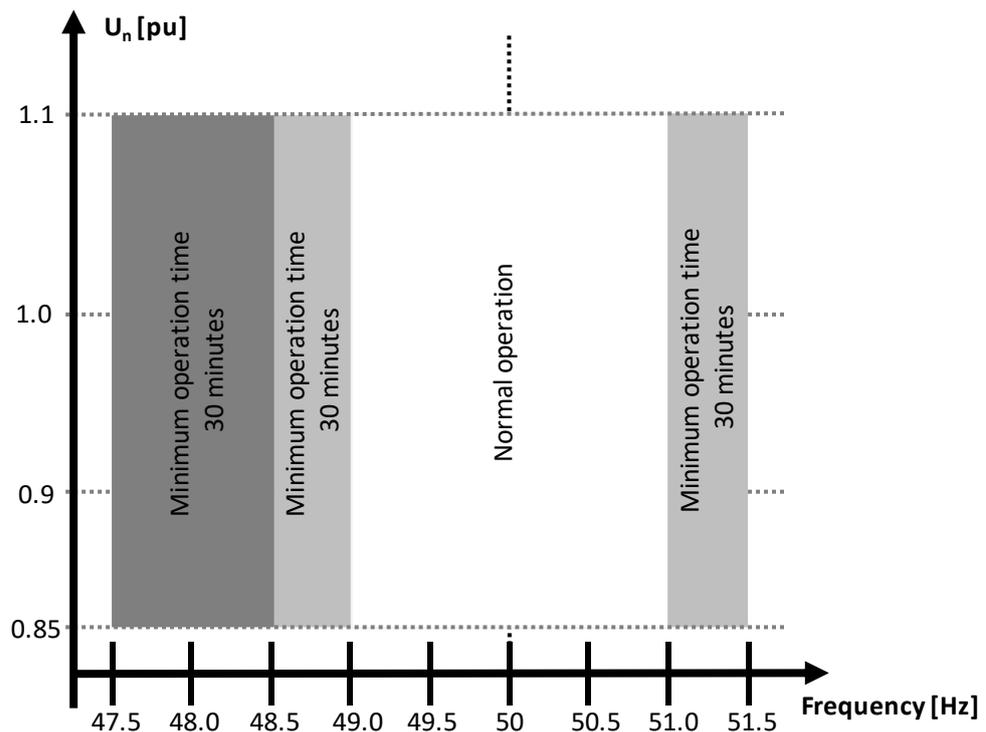

Figure 5.1 – Minimum time periods during which a power-generating plant must be capable of maintaining operation at different frequencies without disconnecting from the grid.

A power-generating plant must be designed to withstand transient voltage phase jumps of up to 20 degrees at the Point of Connection (POC) without disconnecting.

**5.1.2. Tolerance of frequency deviations**

The power-generating plant must be capable of maintaining operation in case of frequency deviations for the time periods specified in figure 5.3 without disconnecting from the public electricity supply grid.

**5.1.2.1. Frequency change**

A power-generating plant must be capable of continuous generation when frequency changes up to 2.0 Hz/s.

**5.1.2.2. Permitted reduction of active power at underfrequency**

A power-generating plant is permitted to reduce the active power within the 49 Hz-47.5 Hz frequency range. In this range, it is permitted to reduce the active power by 6% of  $P_n/Hz$  as shown in figure 5.2.

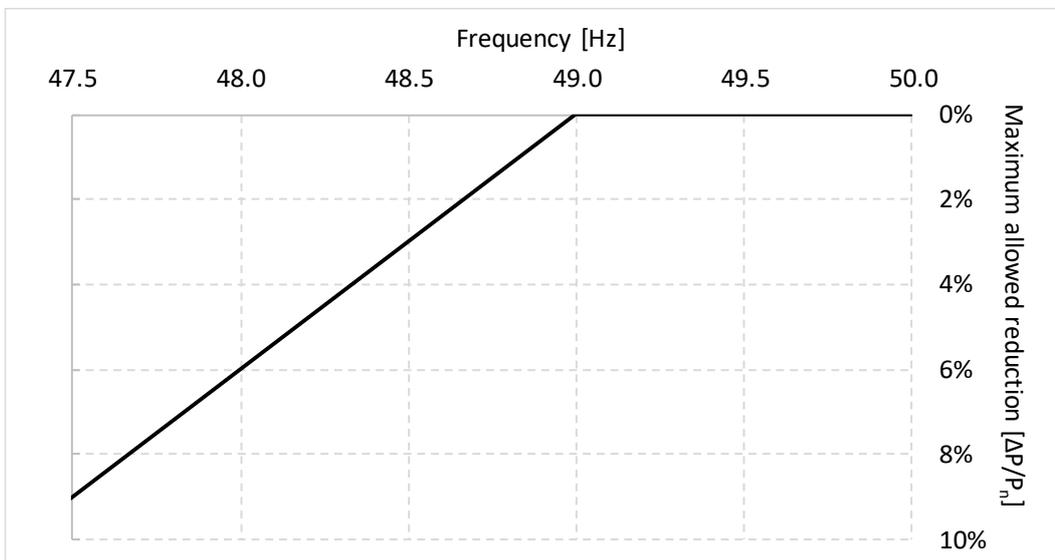

Figure 5.2 – Permitted reduction of active power during underfrequency.

Permitted reduction of active power	
Frequency range	49 Hz - 47.5 Hz
Reduction of $P_n/Hz$	6%

Table 5.1 – Permitted reduction of active power during underfrequency.

A power-generating plant may only reduce the active power if the power-generating plant is technically incapable of continuing to supply full active power at underfrequency. This applies during normal operating conditions, which are guaranteed for 90% of the time, and must occur to the best of its ability in relation to operating point and available primary energy.

### 5.1.3. Tolerance of voltage deviations

A power-generating plant must comply with the requirements for withstanding voltage deviations as specified in this section. Specific requirements apply, depending on power-generating plant type.

#### 5.1.3.1. Permitted reduction of active power at undervoltage

When the voltage at the Point of Connection (POC) is less than 100% of nominal value, it is allowed to reduce the generation of active power to comply with the power-generating plant's current limitation. The reduction must be as small as technically possible.

#### 5.1.3.2. Tolerance to voltage swells

A power-generating plant must be capable of remaining connected to the grid during voltage swells as specified in table 5.2.

Voltage	Duration
$1.15 \cdot U_n$	60 s
$1.20 \cdot U_n$	5 s

Table 5.2 – Tolerance to voltage swells.

#### 5.1.3.3. Tolerance to voltage dips

##### (a) Synchronous power-generating plants

A synchronous power-generating plant must be capable of withstanding voltage dips as shown in figure 5.3. A synchronous power-generating plant must be capable of remaining connected to the grid during voltage dips above the solid line in figure 5.3. In case of voltage dips below the solid line, it is allowed to disconnect the power-generating plant from the grid. This applies to both symmetrical and asymmetrical faults.

The synchronous component of voltage is used to assess the tolerance requirement in figure 5.3. The requirement is assessed at  $P_n$  and Power Factor 1.0. The DSO must, at the power-generating plant owner's request, state the short-circuit power at the Point of Connection (POC) before and after the fault. The short-circuit power may be stated as generic values based on typical operating situations.

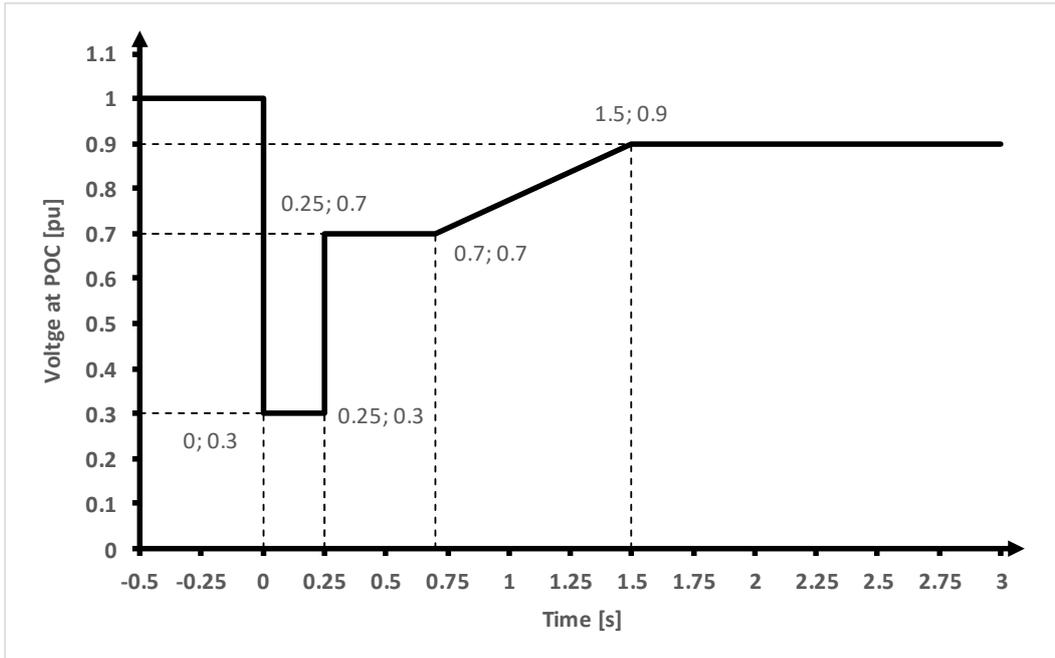

Figure 5.3 – Tolerance to voltage dips for a synchronous power-generating plant.

A synchronous power-generating plant must be capable of restoring normal generation of active power after a fault as quickly as possible after voltage and frequency have returned to the normal operating range, see section 5.1.1. The power-generating plant’s natural ability to restore generation of active power must not be artificially or unnecessarily restricted.

**(b) Power park modules**

A power park module must be capable of withstanding voltage dips as shown in figure 5.4. A power park module must be capable of remaining connected to the grid during voltage dips above the solid line in figure 5.4. In case of voltage dips below the solid line, it is allowed to disconnect the plant from the grid. This applies to both symmetrical and asymmetrical faults.

The synchronous component of voltage is used to assess the tolerance requirements in figure 5.4. The requirement is assessed at  $P_n$  and Power Factor 1.0. The DSO must, at the plant owner’s request, state the short-circuit power at the Point of Connection (POC) before and after the fault.

The short-circuit power may be stated as generic values based on typical operating situations.

A power park module must be capable of restoring normal generation of active power after a fault as quickly as possible; however, no later than five seconds after voltage and frequency have returned to the normal operating range, see section 5.1.1. During the recovery process, upward regulation of active power must be performed with a gradient of at least  $20\% P_n/s$ .

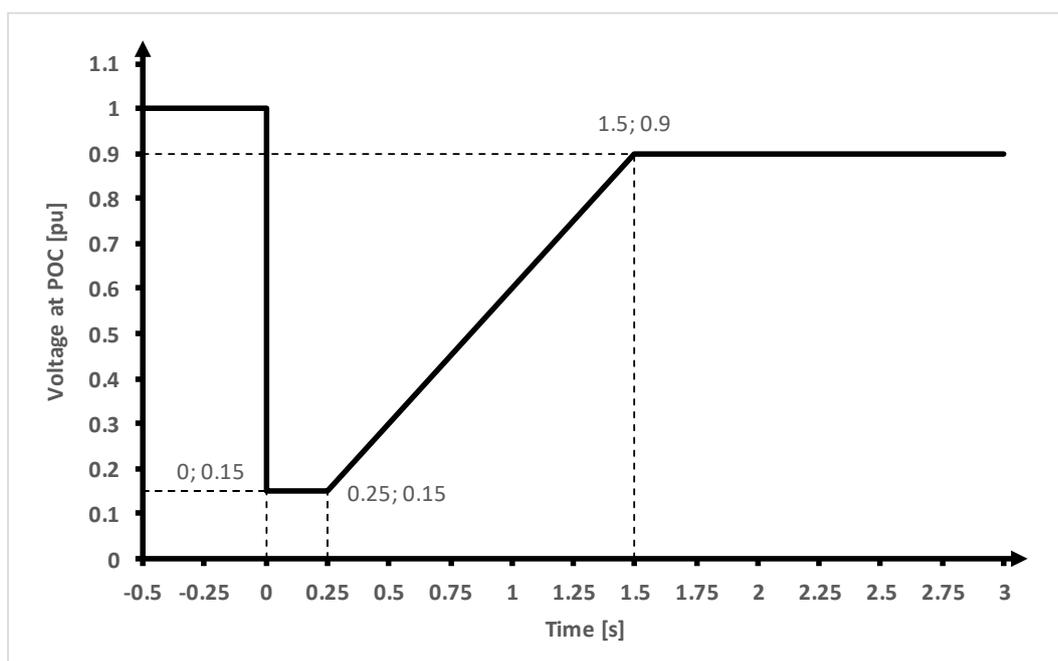

Figure 5.4 – Tolerance to voltage dips for a power park module.

#### Supply of fast fault current during voltage dips

A power park module must be capable of supplying fast fault current,  $I_{\alpha}$ , at the Point of Generator Connection (PGC) in case of a symmetrical fault (three-phase fault) to maintain grid voltage stability during and after a fault.

A power park module must be capable of supplying fast fault current (positive sequence component) in the area above the solid line in figure 5.4 and up to 90% of the normal operating voltage at the Point of Generator Connection (PGC).

Control of fast fault current from a power park module must follow figure 5.5.

It must be possible to supply fast fault current within 100 ms with an accuracy of  $\pm 20\%$  of  $I_n$ .

During a fault sequence, a power park module must prioritise the fast fault current before supplying the active power in the range from 90% to 15% of  $U_n$ , see the hatched area in figure 5.5.

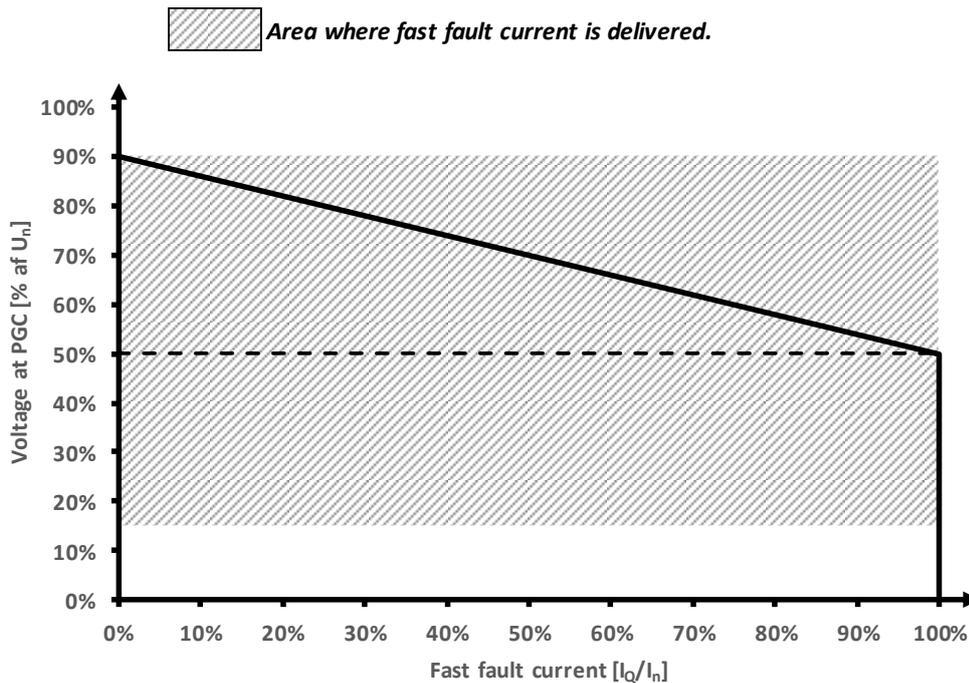

Figure 5.5 – Supply of fast fault current from a power park module.

**5.2. START-UP AND RECONNECTION OF A POWER-GENERATING PLANT**

Start-up and reconnection of a power-generating plant is only permitted when frequency and voltage are within the following ranges:

	DK 1 (Western Denmark)	DK 2 (Eastern Denmark)
Frequency range	47.5 Hz - 50.2 Hz	47.5 Hz - 50.5 Hz
Voltage range	85%-110% $U_n$	85%-110% $U_n$
Observation time	Three minutes	Three minutes

Table 5.3 – Criteria for start-up and reconnection of a power-generating plant.

When a power-generating plant has been connected, the active power must not increase by more than 20% of nominal power per minute.

**5.2.1. Synchronisation**

A power-generating plant must be capable of automatically synchronising to the public electricity supply grid. It must not be possible to manually circumvent the automatic synchronisation and allow the power-generating plant to connect without synchronisation.

### 5.3. ACTIVE POWER CONTROL

A power-generating plant must be capable of controlling its active power. It must be possible to indicate set points in steps of 1% of  $P_n$  or better.

Control must be performed with an accuracy of  $\pm 2\%$  of power-generating plant nominal active power ( $P_n$ ). The control accuracy is measured over a period of one minute.

#### 5.3.1. Power response to overfrequency (LFSM-O)

A power-generating plant must be capable of downward regulation of its active power during overfrequency. Downward regulation of active power must be initiated within two seconds at the Point of Connection (POC).

To be able to detect islanding, downward regulation of the active power at the Point of Connection (POC) must not be initiated until after 500 ms.

*If the plant's natural delay (recovery time) for commencement of downward regulation is 500 ms or more, the requirement for delay is met.*

*If the plant's natural delay (recovery time) for commencement of downward regulation is less than 500 ms, the delay must be extended to 500 ms. The additional delay is only imposed when transitioning to frequency response, i.e. when the frequency threshold  $f_{RO}$  is crossed.*

#### **Example**

*A plant's natural delay (recovery time) for commencement of downward regulation is 300 ms. An additional artificial delay (recovery time) of 200 ms is added to make the total delay (recovery time) for the plant 500 ms.*

The downward regulation of active power must be initiated at a frequency threshold ( $f_{RO}$ ) and follow a droop as indicated in figure 5.6, regardless of whether the frequency increases or decreases.

When a power-generating plant's lower limit for active power is reached in connection with the downward regulation, the power-generating plant must keep this minimum level of active power until the grid frequency drops again or until the plant is disconnected for other reasons.

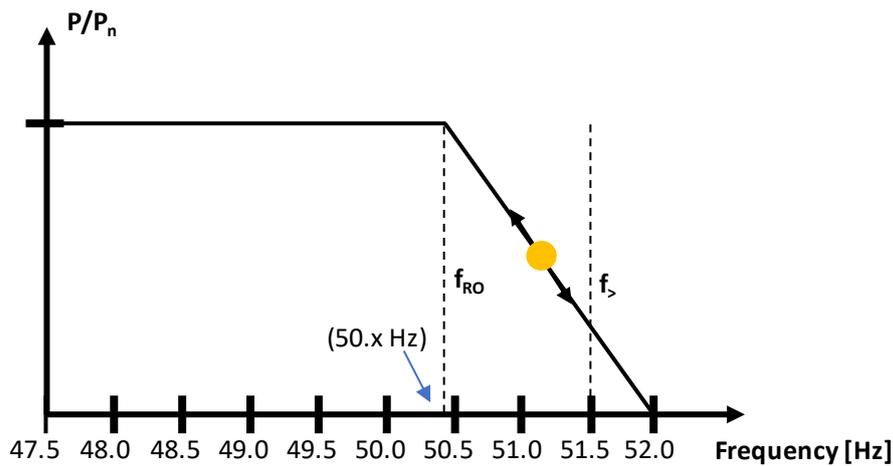

Figure 5.6 – Frequency response droop to overfrequency.

The frequency threshold for commencement of frequency response must be set in the 50.2 Hz - 50.5 Hz frequency range, both values inclusive, with a resolution of 10 mHz or better.

The droop of the active power reduction must be in the 2-12% range with a resolution of 1% or better.

The settings for frequency response to overfrequency for Western and Eastern Denmark are as follows:

	DK 1 (Western Denmark)	DK 2 (Eastern Denmark)
Frequency threshold $f_{RO}$	50.2 Hz	50.5 Hz
Droop	5%	4%
Delay for islanding detection	500 ms	500 ms

Table 5.4 – Default settings for frequency response – overfrequency for DK1 and DK2.

When the frequency response is enabled, the active power must follow the droop with a deviation of 5% of nominal active power or better, measured over a period of one minute.

Frequency must be measured with an accuracy of  $\pm 10$  mHz or better.

### 5.3.2. Limiter functions

#### 5.3.2.1. Absolute power limit

A power-generating plant must be capable of limiting its maximum active power.

Absolute power limit is used to limit the active power from a power-generating plant to a set point-defined maximum power limit at the Point of Connection (POC).

Control to a new value for the absolute power limit must be completed within five minutes of receiving the parameter change order.

#### 5.3.2.2. Ramp rate limit

A power-generating plant must be capable of limiting the gradient of the active power. Unless another functionality, including market services, requires a higher gradient, e.g. active power recovery after a fault etc., the gradient must not exceed more than 20% of the  $P_n/\text{min}$ . This applies to both upward and downward regulation, taking the availability of the primary energy source into consideration.

*Ramp rate limit is used to prevent changes in active power from adversely impacting the stability of the public electricity supply grid.*

#### 5.3.2.3. System protection scheme

The requirement for system protection scheme applies only to power park modules. For synchronous power-generating plants, the needs are assessed when assigning the Point of Connection (POC).

The system protection scheme is a function that, following a downward regulation order, is capable of quickly adjusting the active power supplied from a power-generating plant to one or more predefined set points. Set points are determined by the DSO during commissioning.

The power-generating plant must have at least five configurable set points.

The following default set points are:

1. To 70% of rated power
2. To 50% of rated power
3. To 40% of rated power
4. To 25% of rated power
5. To 0% of rated power, i.e. the power-generating plant is stopped.

Control must be initiated within one second and completed within ten seconds of receipt of a downward regulation order.

## Requirements for type B power-generating plants

---

If the system protection scheme receives an upward regulation order, e.g. from step 4 (25%) to step 3 (40%), it is accepted that completion of the order may take additional time due to the design limits of power-generating plant generators or other plant units.

### 5.4. REACTIVE POWER CONTROL

A power-generating plant must be capable of supplying reactive power. Only one of the following required control functions can be active at a time.

The power-generating plant must be capable of controlling its reactive power using the functions and characteristics described in sections 5.4.2 to 5.4.4. It must be possible to indicate set points in steps of 1% of  $S_n$  or better for power and 0.01 or better for Power Factor.

Control must be performed with an accuracy of  $\pm 2\%$  of the power-generating plant's nominal apparent power. The control accuracy is measured over a period of one minute.

The control accuracy may be worse than  $\pm 2\%$  of  $S_n$  when active power generation is below 10% of power-generating plant nominal apparent power. However, the exchange of uncontrolled reactive power must never be greater than 10% of power-generating plant nominal apparent power.

When one or more power-generating units of a power park module are taken out of operation for scheduled maintenance, the power park module's supply of reactive power may be reduced proportionately to the number of power-generating units taken out of operation.

#### 5.4.1. Reactive power range

The ability to supply reactive power (operating range) depends on the type of power-generating plant. When a power-generating plant is to supply or consume reactive power, it is allowed to reduce the generation of active power in order to comply with the plant nominal apparent power. The reduction must be as small as technically possible.

##### 5.4.1.1. (a) A synchronous power-generating plant

A synchronous power-generating plant must be capable of supplying reactive power at different voltages at the Point of Connection (POC) as specified in figure 5.7.

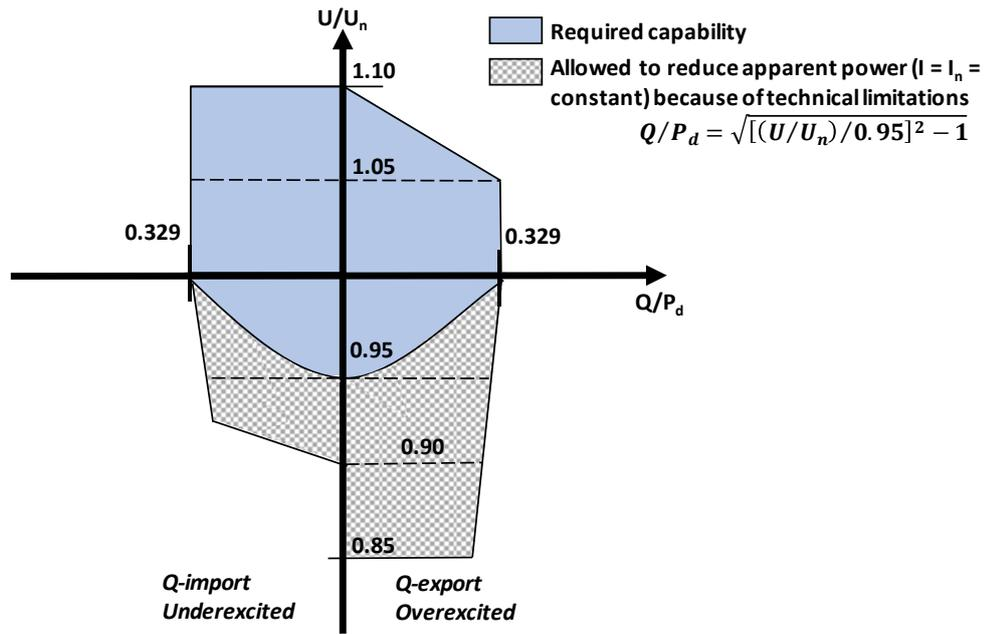

Figure 5.7 – Requirements for supply of reactive power at different voltages at the Point of Connection (POC).

A synchronous power-generating plant must be capable of supplying reactive power at different active power levels as specified in figure 5.8.

For synchronous power-generating plants where  $P_d$  is less than  $P_n$ , operation within the ‘design freedom’ range is allowed. The synchronous power-generating plant must not supply active power greater than  $P_n$ .

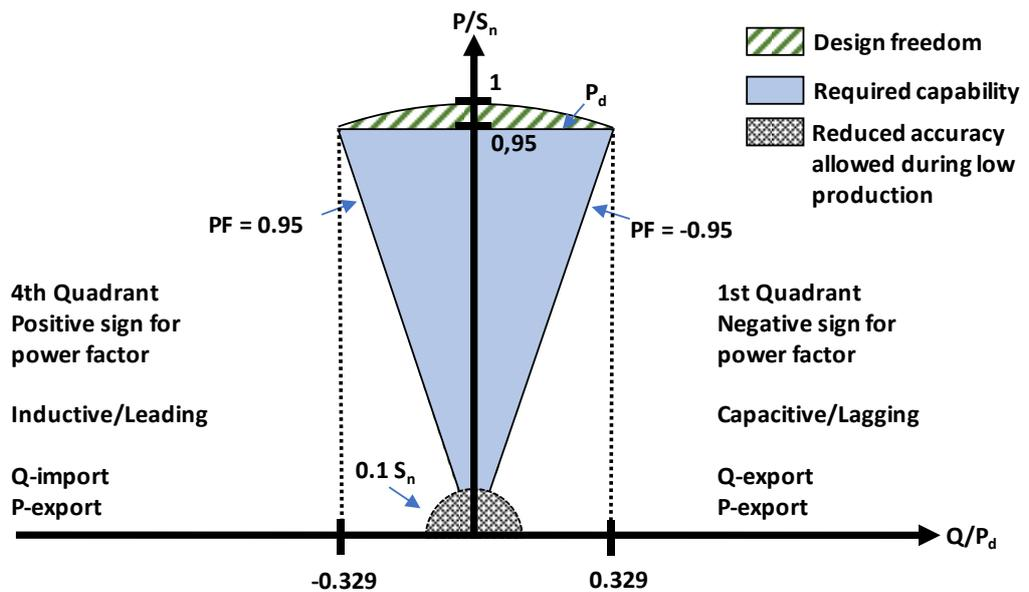

Figure 5.8 – Requirements for supply of reactive power at different active power levels.

Outside the range described in figure 5.7 and figure 5.8, a synchronous power-generating plant must supply stable reactive power in accordance with the selected control mode, which may only be limited by the technical performance of the plant, e.g. saturation or undercompensation.

### 5.4.1.2. (b) A power park module

A power park module must be capable of supplying reactive power at different voltages at the Point of Connection (POC) as specified in figure 5.9.

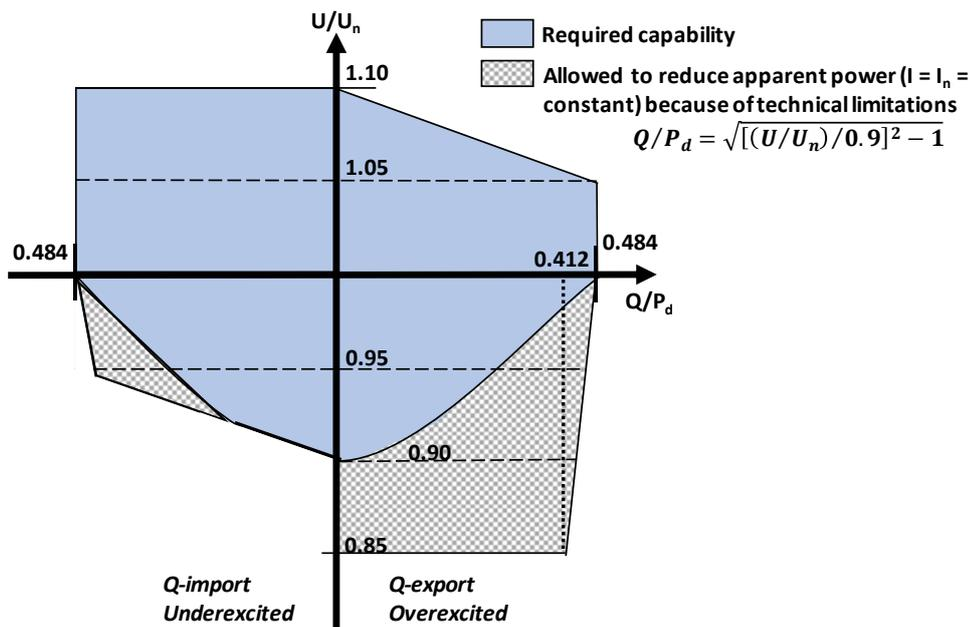

Figure 5.9 – Requirements for supply of reactive power at different voltages at the Point of Connection.

A power park module must be capable of supplying reactive power at different active power levels as specified in figure 5.10.

For power park modules where  $P_d$  is less than  $P_n$ , operating within the 'design freedom' area is allowed. The plant must not supply active power greater than  $P_n$ .

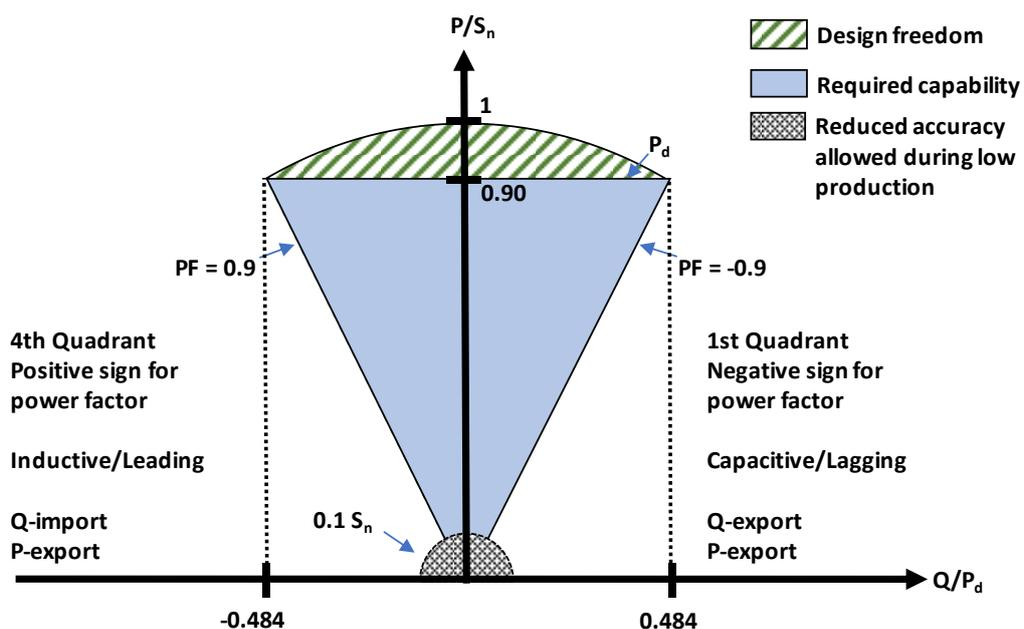

Figure 5.10 – Requirements for supply of reactive power at different active power levels.

Outside the range described in figure 5.9 and figure 5.10, a power park module must supply stable reactive power in accordance with the selected control mode, which may only be limited by the technical performance of the plant, e.g. saturation or undercompensation.

#### 5.4.2. Power Factor control

A power-generating plant must be capable of performing Power Factor control allowing the reactive power to be controlled by means of a fixed Power Factor, see figure 5.11.

When a new Power Factor set point is set, the control must be completed within one minute.

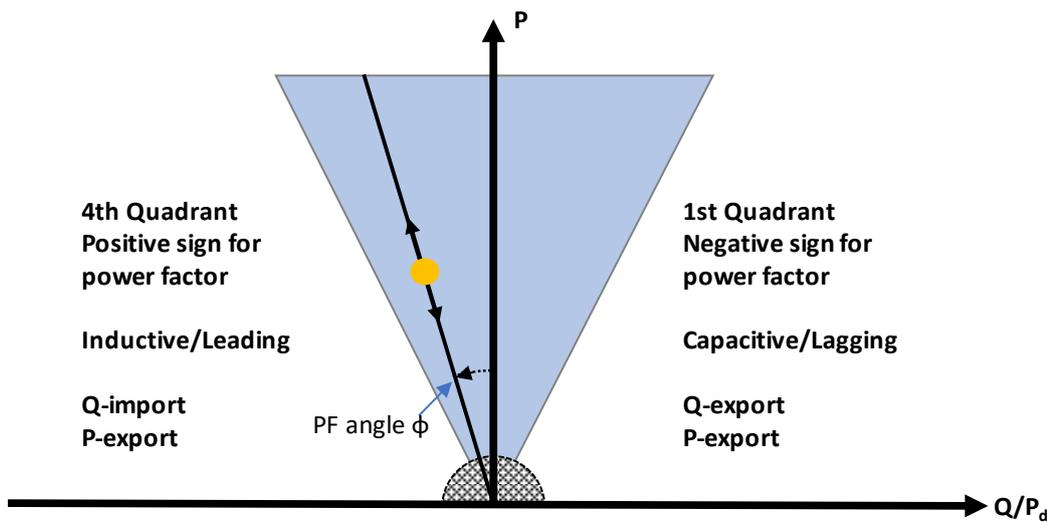

Figure 5.11 – Example of Power Factor control [ $\cos \phi$  set point].

A power-generating plant may not exchange reactive power with the public electricity supply grid unless otherwise agreed with the DSO. I.e. the plant will by default produce at a Power Factor of 1.

If the function is to be enabled, the setting values for the control function are agreed with the DSO.

### 5.4.3. Automatic Power Factor control

A power-generating plant must be capable of performing automatic Power Factor control as shown in figure 5.12.

Reactive power control must be completed within ten seconds after the active power has stabilised.

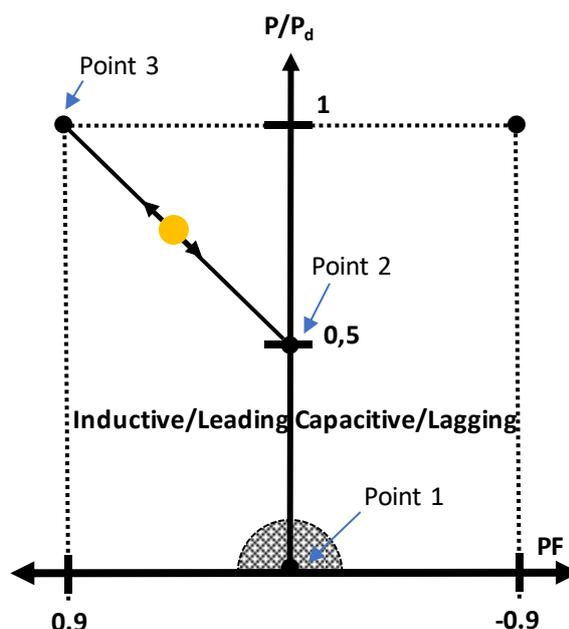

Figure 5.12 – Default setting for automatic Power Factor control [ $\cos \phi$  (P)].

Default settings for the characteristics are specified in table 5.5.

Characteristics points		
Point	$P/P_n$	Power Factor
1	0.0	1.0
2	0.5	1.0
3	1	0.9 inductive

Table 5.5 – Characteristic points.

The function is normally activated at 105% of  $U_n$  and deactivated at 100% of  $U_n$ .

A power-generating plant may not exchange reactive power with the public electricity supply grid unless otherwise agreed with the DSO. I.e. the plant will by default always produce at a Power Factor of 1.

If the function is to be enabled, the setting values for the control function are agreed with the DSO.

#### 5.4.4. Q control

A power-generating plant must be capable of performing Q control as shown in figure 5.13.

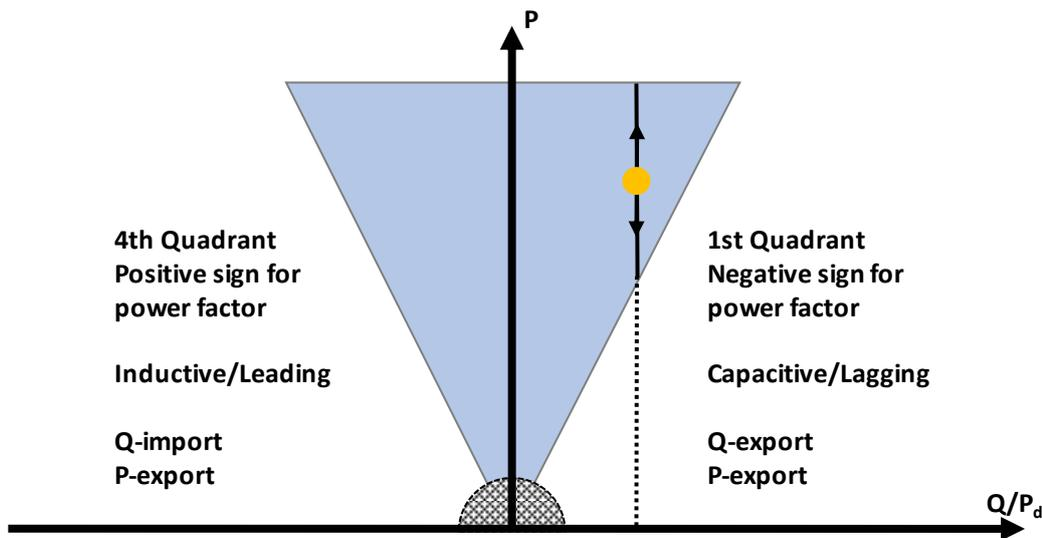

Figure 5.13 – Example of Q control [Q set point].

Control from one set point to another must be completed within one minute.

A power-generating plant may not exchange reactive power with the public electricity supply grid unless otherwise agreed with the DSO. I.e. the plant must produce by default Power Factor of 1.

If the function is to be enabled, the current setting values for the control function are agreed with the DSO.

### 5.4.5. (a) Synchronous power-generating plants – additional requirements

In addition to the general requirements for reactive power, synchronous power-generating plants must also be equipped with a constantly working automatic excitation system. The excitation system must be capable of supplying stable and constant voltage at the PGC. It must be possible to select the voltage set point in the entire voltage range for normal operation.

## 5.5. PROTECTION

### 5.5.1. General

Power-generating plant protection must both protect the plant and help ensure stability in the public electricity supply grid.

Relay settings must not prevent specified power-generating plant functions from working properly.

The power-generating plant owner is responsible for ensuring that the plant is dimensioned and equipped with the necessary protection functions so that the plant:

- Is protected against damage due to faults and incidents in the public electricity supply grid
- Protects the public electricity supply grid against unwanted impacts from the power-generating plant
- Is protected against damage as a result of asynchronous connections
- Is protected against disconnection in non-critical situations for the power-generating plant
- Is not damaged and does not switch off during voltage dips as specified in section 5.1.3.

The DSO or the transmission system operator may demand that the setting values for protection functions be changed after commissioning of the power-generating plant if it is deemed to be of importance to the operation of the public electricity supply grid.

Following disconnection of a power-generating plant due to a fault in the public electricity supply grid, the plant must not reconnect automatically earlier than specified in section 5.2.

A power-generating plant which has been disconnected by an external signal prior to a fault occurring in the public electricity supply grid must not be connected until the external signal has been eliminated and the voltage and frequency are once again within the range specified in section 5.2.

At the plant owner's request, the DSO must state the highest and lowest short-circuit current that can be expected at the Point of Connection (POC) as well as any other information about the public electricity supply grid as may be necessary to configure the power-generating plant's protection functions.

Voltage and frequency must be measured simultaneously for the phases which the power-generating plant is connected to at the Point of Connection (POC).

### **5.5.2. Requirements for protection functions and settings**

The power-generating plant's protection functions and associated settings must be as specified in the following subsections. Settings deviating from the default setting values specified in this document, e.g. in the event of problems with local overvoltages, may only be used with the DSO's permission.

## Requirements for type B power-generating plants

---

In connection with internal short circuits in the power-generating plant, the relay protection must be selective with the grid protection. This means that short circuits in the power-generating plant must be disconnected within 100 ms.

All settings are stated as RMS values.

The power-generating plant must be disconnected or shut down if a measured signal deviates more from its nominal value than the setting.

The trip time stated is the measuring period during which the trip condition must constantly be fulfilled in order for the protection function to release a trip signal.

The accuracy of voltage and frequency measurements must be  $\pm 1\%$  of  $U_n$  and  $\pm 0.05$  Hz or better respectively.

The frequency change is calculated according to the following or equivalent principle.

The frequency measurement used to calculate the frequency change is based on a 200 ms measuring period where the mean value is calculated.

Frequency measurements must be made continuously, so that a new value is calculated for each 20 ms.

ROCOF must be calculated as the difference between the currently performed frequency mean value calculation and the mean value calculation performed 20 ms before.

$(df/dt = (\text{mean value 2} - \text{mean value 1})/0.020 \text{ [Hz/s]})$ .

If a power-generating plant is isolated with part of the public electricity supply grid, the plant must not cause temporary overvoltages that can damage the plant or the public electricity supply grid.

### 5.5.3. Requirements for grid protection

A power-generating plant must have protection functions as specified in table 5.6. Unless otherwise agreed with the DSO, the default values in the table are to be used. The ranges and resolutions are indicative, not required.

Protection function	Symbol	Setting (Range/Resolution)		Trip time (Range/Resolution)	
Overvoltage (step 2)	$U_{>>}$	1.0 - 1.3/0.01 Default: 1.15	$U_n$	0.1 - 5/0.05 Default: 0.2	s
Overvoltage (step 1)	$U_{>}$	1.0 - 1.2/0.01 Default: 1.10	$U_n$	0.1 - 100/0.1 Default: 60	s
Undervoltage (step 1)	$U_{<}$	0.2 - 1.0/0.01 Default: 0.85	$U_n$	0.1 - 100/0.1 Default: 50	s
Overfrequency	$f_{>}$	50.0 - 52.0/0.1 Default: 51.5	Hz	0.1 - 5/0.05 Default: 0.2	s
Underfrequency	$f_{<}$	47.0 - 50.0/0.1 Default: 47.5	Hz	0.1 - 5/0.05 Default: 0.2	s

Table 5.6 – Requirements for all power-generating plants, regardless of type.

#### 5.5.3.1. (a) Additional requirements for grid protection of synchronous power-generating plants

In addition to the general protection functions and settings, synchronous power-generating plants must also have the protection functions and settings specified in table 5.7.

A synchronous undervoltage relay is only required when the DSO deems that there is a risk of asynchronous connection. The DSO determines the setting values for the synchronous undervoltage relay.

*The DSO to whose grid the plant is connected calculates the setting values for the synchronous undervoltage relay using the principles in the Research Association of the Danish Electric Utilities (DEFU) technical report no. 293, 3rd edition on 'Relay protection at local production with synchronous generators', March 2018.*

It is allowed to use a fuse instead of overcurrent relay (step 1). In this case, the fuse size and characteristics must be approved by the DSO.

## Requirements for type B power-generating plants

Protection function	Symbol [IEC]	Setting		Trip time	
Synchronous undervoltage*	-	Determined by the DSO	V	≤50	ms
Overcurrent (step 2)**	$I_{>>}$	Determined by the DSO	A	50	ms
Overcurrent (step 1)	$I_{>}$	1.2	$I_n$	2	s

\*) If synchronous undervoltage relay is used.  
Synchronous undervoltage relay: The setting is dependent on local generator and grid data. The setting is calculated by the DSO.

\*\* ) If synchronous undervoltage relay is not used, the generator manufacturer's settings for overcurrent protection are used.

Table 5.7 – Additional protection settings for synchronous power-generating plants.

### 5.5.4. Requirements for islanding detection

A power-generating plant must be capable of detecting unintentional island operation and must disconnect from the public electricity supply grid if unintentional islanding is detected.

In Denmark, only passive islanding detection methods are used. The use of vector jump relays (ANSI 78) or active islanding detection is not allowed on power-generating plants connected to the Danish public electricity supply grid.

A power-generating plant must have the functions for islanding detection specified in table 5.8. Unless otherwise agreed with the DSO, the default value in the table is used. The ranges and resolutions are indicative, not required.

Protection function	Symbol	Setting (Range/Resolution)		Trip time (Range/Resolution)	
Frequency change	df/dt	0-3.5/0.1 Default: ±2.5	Hz/s	0-5/0.01 Default: 0.08	s

Table 5.8 – Requirements for islanding detection.

### 5.5.5. Earthing

Requirements related to earthing of the power-generating plant must be agreed with the DSO.

## 5.6. POWER QUALITY

A power-generating plant must not cause unacceptable power quality in the grid. To avoid this, the power-generating plant must comply with the requirements specified in the following sections.

### 5.6.1. Emission limits

A power-generating plant must comply with the requirements described in the following sections.

*The emission limits in sections 5.6.1.1 to 5.6.1.7 of these instructions are based on the Research Association of the Danish Electric Utilities (DEFU) report RA 557 and the principles in IEC/TR 61000-3-14.*

#### 5.6.1.1. DC content

A power-generating plant may not inject DC currents into the grid. This requirement is met if the DC content of the current injected by the plant into the grid is below 0.5% of the nominal current of the plant.

If the power-generating plant is connected to the grid by means of a plant transformer, it is assumed that this requirement is met.

*The reason for having a limit value for DC content is that DC currents are undesirable in the public electricity supply grid and may have an adverse effect on grid operation and protection. The limit value is set based on IEC/TR 61000-3-15, which provides recommendations for requirements for local production connected to the public electricity supply grid at low-voltage level.*

#### 5.6.1.2. Current unbalance

The power-generating plant must have balanced three-phase load.

#### 5.6.1.3. Rapid voltage changes

A power-generating plant must not cause rapid voltage changes exceeding the limit value specified in table 5.9.

Limit value

$d(\%) = 4\%$

Table 5.9 – Limit for rapid voltage changes as a percentage of  $U_n$ .

## Requirements for type B power-generating plants

*Requirements for rapid voltage changes are based on DS/EN 61000-3-11 and the Research Association of the Danish Electric Utilities (DEFU) report RA 557 as well as the methods for determining limit values described in IEC/TR 61000-3-14.*

### 5.6.1.4. Flicker

A power-generating plant must not cause flicker contributions exceeding the limits for short-term and long-term flicker as specified in table 5.10.

	Short-term flicker ( $P_{st}$ )	Long-term flicker ( $P_{lt}$ )
Limit value	0.35/0.45/0.55*	0.25/0.30/0.40*
*Limits apply if 4+/2/1 power-generating plants are connected to the same substation.		

Table 5.10 – Limit value for short-term and long-term flicker.

*Flicker limit values are based on DS/EN 61000-3-11 and the Research Association of the Danish Electric Utilities (DEFU) report RA 557 as well as the methods for determining limit values described in IEC/TR 61000-3-14.*

### 5.6.1.5. Harmonics

A power-generating plant may not emit harmonic currents exceeding the limits in table 5.11 for the individual harmonics, which are expressed as a percentage of the nominal current of the plant ( $I_h/I_n$  (%)). The limits depend on the SCR between a power-generating plant's nominal apparent power and the short-circuit power at the plant's Point of Connection (POC).

SCR	Odd-order harmonics h							Even-order harmonics h					
	3	5	7	9	11	13	15	2	4	6	8	10	12
<33	3.4	3.8	2.5	0.5	1.2	0.7	0.35	0.5	0.5	1.0	0.8	0.6	0.5
≥33	3.5	4.1	2.7	0.5	1.3	0.7	0.37	0.5	0.5	1.0	0.8	0.6	0.5
≥66	3.9	5.2	3.4	0.6	1.8	1.0	0.43	0.5	0.5	1.0	0.8	0.6	0.5
≥120	4.6	7.1	4.6	0.8	2.5	1.5	0.5	0.5	0.5	1.0	0.8	0.6	0.5
≥250	6.3	11.6	7.3	1.3	4.4	2.7	0.8	0.5	0.5	1.0	0.8	0.6	0.5
≥350	7.5	15.0	9.5	1.6	5.7	3.7	1.0	0.5	0.5	1.0	0.8	0.6	0.5

Table 5.11 – Limits for harmonic currents  $I_h/I_n$  (% of  $I_n$ ).

In addition to the limits for the individual harmonics, there are also limits for total harmonic emissions. Limits for  $THD_I$  and  $PWHD_I$  are specified in table 5.12.

SCR	$THD_I$	$PWHD_I$
<33	4.4	4.4
≥33	4.7	4.7
≥66	6.1	6.1
≥120	8.4	8.4
≥250	13.8	13.8
≥350	18.0	18.0

Table 5.12 – Limits for  $THD_I$  and  $PWHD_I$  in current (%  $I_n$ ).

*The requirements for individual harmonics,  $THD_I$  and  $PWHD_I$ , are based on DS/EN 61000-3-12 Table 3 and the Research Association of the Danish Electric Utilities (DEFU) report RA 557 as well as the methods for determining limit values described in IEC/TR 61000-3-14.*

*The 2nd and 4th order harmonics are reduced compared to the method in RA 557, because they may indicate DC content in the current supplied to the public electricity supply grid. Exceeding the limit values for the 2nd or 4th harmonic orders may indicate that the plant does not meet the requirement for DC content.*

*Triplen harmonics are added based on their ratio of the limit values in DS/EN 50160. Triplen harmonics should not occur at all in balanced three-phase equipment. However, three-phase inverters have been observed to produce these harmonics at times due to the inverter control. Therefore, it has been decided to add a limit for them. In practice, the limits for triplen harmonics in these instructions have been set high enough that they should never constitute a problem in a balanced three-phase plant. If a plant exceeds these limits, this will indicate that the plant cannot be categorised as being balanced, and it can therefore not be connected, because it does not comply with the unbalance requirements.*

**5.6.1.6. Interharmonic overtones**

A power-generating plant must comply with the current emission limits specified for all interharmonic overtones as specified in table 5.13.

SCR	Frequency (Hz)		
	75 Hz	125 Hz	>175 Hz
<33	0.4	0.6	$\frac{75}{f}$ *
≥33	0.5	0.7	$\frac{83}{f}$ *
≥66	0.6	0.8	$\frac{104}{f}$ *
≥120	0.7	1.1	$\frac{139}{f}$ *
≥250	1.2	1.8	$\frac{224}{f}$ *
≥350	1.5	2.3	$\frac{289}{f}$ *

**\*However, not less than the measurement uncertainty.**

**Table 5.13 – Limits for interharmonic overtones, expressed in current (% of I<sub>n</sub>).**

*Limits for interharmonic overtones are based on DS/EN 61000-3-12 and the Research Association of the Danish Electric Utilities (DEFU) report RA 557 as well as the methods for determining limit values described in IEC/TR 61000-3-14.*

**5.6.1.7. Distortions in the 2-9 kHz frequency range**

A power-generating plant must comply with the current emission limits specified in table 5.14 for all 200 Hz frequency groups between 2 kHz and 9 kHz.

Limit value
0.2%

**Table 5.14 – Limits in current stated as a percentage of I<sub>n</sub> for all frequencies between 2 kHz and 9 kHz.**

*Limits for distortions in the 2-9 kHz frequency range is based on the Research Association of the Danish Electric Utilities (DEFU) report RA 557.*

### 5.6.2. Division of responsibilities

#### 5.6.2.1. The power-generating plant owner's obligations

As a rule, the power-generating plant owner must ensure that the plant is designed, constructed and configured to comply with all emission limits.

The power-generating plant owner must verify that emission limits at the Point of Connection (POC) are complied with.

For calculation of power quality, the power-generating plant owner uses the typical three-phase short-circuit power,  $S_{k,\text{powerquality}}$  at the Point of Connection (POC).

*Subject to agreement, the plant owner can buy additional services (higher short-circuit power or higher subscribed capacity) from the DSO in order to comply with the specified limit values.*

#### 5.6.2.2. The DSO's obligations

The DSO is responsible for setting emission limits at the point of connection.

The DSO must specify the short-circuit level  $S_{k,\text{powerquality}}$  with associated impedance angle  $\psi_k$  at the Point of Connection (POC).

#### 5.6.3. Measuring method

Measurements of various power quality parameters must be carried out in accordance with the European standard DS/EN 61000-4-30 (class A).

Measurement of harmonic distortion of voltage and current must be carried out as defined in IEC 61000-4-7 in accordance with the principles (harmonic subgroup) and with the accuracies specified for class I.

Measurement of interharmonic distortion up to 2 kHz must be carried out as defined in IEC 61000-4-7 Annex A and must be measured as interharmonic subgroups.

Alternatively, it is allowed to measure harmonic distortion up to 2 kHz with grouping enabled (harmonic groups) as specified in IEC 61000-4-7 and with the accuracies specified for class I. If harmonic distortion up to 2 kHz is measured with grouping enabled, it is not required to measure interharmonic distortion up to 2 kHz separately.

Measurement of distortions in the 2-9 kHz frequency range must be carried out as defined in IEC 61000-4-7 Annex B and must be measured in 200 Hz windows with centre frequencies from 2100 Hz to 8900 Hz.

### 5.7. EXCHANGE OF INFORMATION

A power-generating plant must be equipped with an interface at the PCOM enabling real-time exchange of signals.

If a power-generating plant consists of more units, a plant controller must be installed to allow control of the plant as a complete power-generating plant at the PCOM, see figure 3.3 and figure 3.4.

A power-generating plant must be capable of ceasing its active power generation. Generation must be stopped no later than five seconds after the command to this effect has been received. Furthermore, a power-generating plant must be capable of reducing active power upon receiving a command.

#### 5.7.1. Requirements for time stamping and update speed

Exchange of information must be time stamped. The timestamps shall have the following update times.

- Maximum time to update functional status (enabled/disabled) is 10 ms.
- Maximum time to update parameter value is one second.
- Maximum time to update metering values is one second.

#### 5.7.2. Information exchange requirements for power-generating plants below 1 MW.

A power-generating plant below 1 MW must at a minimum be capable of exchanging the following information:

Signal description	Signal type
Stop signal	Command
Hold signal – ‘Released for start’	Command

Figure 5.14 – Requirements for information which a power-generating plant below 1 MW must be capable of exchanging.

The need for remote control of these signals is assessed by the DSO at grid connection.

A power-generating plant may start production after the conditions for reconnection are fulfilled (see sect. 4.2), and “Released for start” is received.

### 5.7.3. Requirements for information exchange for power-generating plants of 1 MW and above

Power-generating plants with nominal active power of 1 MW and above must as a minimum be capable of exchanging the following information in real time:

Signal description	Signal type
Stop signal	Command
Hold signal – ‘Released for start’	Command
Absolute power limit	Set point
Absolute power limit	Enabled/disabled
Main circuit breaker indicator	Status
Generator circuit breaker indicator	Status
Active power	Measurement
Reactive power	Measurement
Current	Measurement
Voltage	Measurement
Power Factor (PF)	Measurement (may also be computed values)
Q control	Set point
Q control	Enabled/disabled
Power Factor control	Set point
Power Factor control	Enabled/disabled

**Table 5.15 – Requirements for information which a power-generating plant of 1 MW or more must be capable of exchanging in real time in the PCOM interface.**

A power-generating plant may start production after the conditions for reconnection are fulfilled (see sect. 5.2), and “Released for start” is received.

### 5.8. VERIFICATION AND DOCUMENTATION

This section describes the documentation to be provided by the power-generating plant owner or a third party to the DSO in order to obtain operational notification.

## Requirements for type B power-generating plants

---

The power-generating plant owner is responsible for complying with the requirements described in this document and for documenting such compliance.

The DSO may at any time request verification and documentation showing that the power-generating plant meets the requirements described in this document.

### 5.8.1. Documentation requirements

- CE Declaration of Conformity
- Protection function settings
- Single-line diagram
- Power quality
- Tolerance of voltage dips
- Annex B2.1 complete with technical documentation in support of the answers given.
- Annex 0 completed.

Product certificates issued by an approved certification body may also be used. The product certificates may cover some of the documentation requirements.

In connection with documentation of the power-generating plant's technical properties, testing and simulations must be performed as described in sections 5.8.2 and 0.

### 5.8.2. Tests

As part of the documentation of the power-generating plant's technical properties, testing must be performed to demonstrate compliance with the requirements of this document. The tests to be carried out include:

- Power response to overfrequency (LFSM-O)

Results must be presented in a report.

Product certificates issued by an approved certification body may be used instead of tests.

### 5.8.3. Simulations

As part of the documentation of the power-generating plant's technical properties, simulations must be performed to demonstrate compliance with the requirements of this document. The simulations to be carried out include:

- Power response to overfrequency (LFSM-O)
  - Must be carried out for frequency changes in both steps and ramps.
  - Must show how the power-generating plant reacts when reaching the lower active power limit.
- Tolerance to voltage dips
- Active power recovery

- Supply of fast fault current (only power park modules)

Simulation results and simulation model must be validated against the tests carried out to demonstrate that model and simulations are accurate.

Product certificates issued by an approved certification body may be used instead of simulations.

### ***CE Declaration of Conformity***

*CE Declarations of Conformity must be submitted for each of the main components. The CE Declaration of Conformity must contain a list of relevant standards, codes of practice and directives which the component or plant complies with.*

### ***Protection functions***

*Documentation of protection settings is a list of all current relay configurations at the time of commissioning.*

### ***Single-line diagram***

*A single-line diagram is a drawing that shows the plant's main components and how they are electrically interconnected. In addition, the location of the protection and measuring points are included in the representation.*

### ***Power quality***

*Power quality is a collection of parameters characterising the electricity supplied. A certificate or report demonstrating that the requirements are complied with must be presented.*

### ***Tolerance of voltage dips***

*Tolerance of voltage dips is the plant's ability to stay connected to the public electricity supply grid during a voltage dip as well as electricity-generating plants' ability to supply fast fault reactive current. The plant's ability to stay connected to the grid and supply fast fault reactive current may be documented in two ways: simulation or testing.*

### ***Completion of annexes***

*A completed Annex B2.1 means that the annex in these instructions must be completed, and that technical documentation verifying the correctness of the answers given in the annex is attached. Technical documentation may include a test report, product certificate, user manual, simulations, etc.*

**ANNEX 1 DOCUMENTATION FOR TYPE A POWER-GENERATING PLANTS**

**B1.1. Documentation for type A power-generating plants**

Please complete the documentation with power-generating plant data and send it to the DSO.

**B1.1.1. Identification**

Power-generating plant:	Description of the power-generating plant:
Global Service Relation Number (GSRN-nummer):	
Plant owner name and address:	
Plant owner telephone number:	
Plant owner e-mail address:	
Type/model:	
Nominal voltage ( $U_n$ ):	
Rated power ( $P_n$ ):	
Primary energy source:	Wind <input type="checkbox"/> Solar <input type="checkbox"/> Other type of plant* <input type="checkbox"/>  *Describe the type of plant in question

**B1.1.2. Positive list**

Is the power-generating plant included on the positive list?  If not, please fill out annex B1.2 as well. *If the power-generating plant is over 50kW and consists of multiple units, then the power-generating plant needs to document power quality in every connection.	Yes <input type="checkbox"/> No <input type="checkbox"/>
---	---

### B1.1.3. Active power control

#### B1.1.3.1. Power response to overfrequency

Is the frequency response function for overfrequency enabled?	Yes <input type="checkbox"/> No <input type="checkbox"/>
If yes, what are the setting values?	_____ Hz
Frequency threshold ( $f_{RO}$ ):	_____ %
Droop:	_____ ms
Delay for islanding detection (minimum response time):	

### B1.1.4. Reactive power control

#### B1.1.4.1. Power Factor control

Is the Power Factor control function enabled?	Yes <input type="checkbox"/> No <input type="checkbox"/>
If yes, which set point is used? (Values different from $\cos \phi$ 1.0 must be agreed with the DSO)	_____ $\cos \phi$ Inductive <input type="checkbox"/> Capacitive <input type="checkbox"/>

#### B1.1.4.2. Automatic Power Factor control

Is the automatic Power Factor control function enabled? (Must only be enabled subject to prior agreement with the DSO)	Yes <input type="checkbox"/> No <input type="checkbox"/>
If yes, which set points are used?	
Set point 1 – P/Pn	_____ %
Set point 1 – Power Factor (inductive)	_____ $\cos \phi$
Set point 2 – P/Pn	_____ %
Set point 2 – Power Factor (inductive)	_____ $\cos \phi$
Set point 3 – P/Pn	_____ %
Set point 3 – Power Factor (inductive)	_____ $\cos \phi$

#### B1.1.4.3. Q control

Is the Q control function enabled?	Yes <input type="checkbox"/> No <input type="checkbox"/>
If yes, which set point is used? (Values different from 0 kVAr must be agreed with the DSO)	_____ kVAr

**B1.1.5. Protection**

**B1.1.5.1. Relay settings**

Please state the actual values at the time of commissioning in the table below.

Protection function	Symbol	Setting		Trip time	
Overvoltage (step 2)	$U_{>>}$		V		ms
Overvoltage (step 1)	$U_{>}$		V		s
Undervoltage (step 1)	$U_{<}$		V		s
Undervoltage (step 2)*	$U_{<<}$		V		ms
Overfrequency	$f_{>}$		Hz		ms
Underfrequency	$f_{<}$		Hz		ms
Frequency change*	$df/dt$		Hz/s		ms

\*At least one of the functions must be enabled

**B1.1.5.2. Additional requirements for grid protection of synchronous power-generating plants**

Is synchronous undervoltage relay used to prevent asynchronous connection?	Yes <input type="checkbox"/> No <input type="checkbox"/>
--	---

**B1.1.5.3. Additional relay settings for synchronous power-generating plants**

Please state the actual values at the time of commissioning in the table below.

Protection function	Symbol	Setting		Trip time	
Overcurrent	$I_{>}$		A		ms
Synchronous undervoltage*			V		ms

\*If a synchronous undervoltage relay is used.

**B1.1.6. Signature**

Date of commissioning:	
Contractor:	
Responsible	
Signature (Responsible):	
Plant owner:	
Signature (plant owner):	

**B1.2. Documentation for type A power-generating plants**

Please complete the documentation with power-generating plant data and send it to the DSO.

**B1.2.1. Identification**

Power-generating plant:	Description of the power-generating plant:
Plant owner name and address:	
Plant owner telephone number:	
Plant owner e-mail address:	
Type/model:	
Nominal voltage ( $U_n$ ):	
Rated power ( $P_n$ ):	
Primary energy source:	Wind <input type="checkbox"/> Solar <input type="checkbox"/> Other type of plant* <input type="checkbox"/> *Describe the type of plant in question

**B1.2.2. EN50549-1**

Is the power-generating plant in accordance with the requirements in EN50549-1?  If yes, please provide reference to documentation:  Demands in <i>italic</i> must be answered. Demands in questions with normal letters are included in EN50549-1	Yes <input type="checkbox"/> No <input type="checkbox"/>
---	---

**B1.2.3. Tolerance of frequency and voltage deviations**

**B1.2.3.1. Phase jump**

<p>Does the power-generating plant remain connected during voltage phase jumps of 20 degrees at the POC as specified in section 4.1.1?</p> <p>If yes, please provide reference to documentation:</p>	<p>Yes <input type="checkbox"/></p> <p>No <input type="checkbox"/></p>
--	--

**B1.2.3.2. Operating area for voltage and frequency**

<p>Is the power-generating plant capable of remain connected to the public electricity supply grid within the voltage and frequency range specified in section 4.1.1 and 4.1.2 and on figure 4.1 and generating continuously within the normal operating range.</p> <p>If yes, please provide reference to documentation:</p>	<p>Yes <input type="checkbox"/></p> <p>No <input type="checkbox"/></p>
---	--

**B1.2.3.3. Frequency change**

<p>Will the power-generating plant remain connected in case of frequency changes of 2.0 Hz/s at the POC?</p> <p>If yes, please provide reference to documentation:</p> <p>-- To be completed for synchronous power generating plant</p>	<p>Yes <input type="checkbox"/></p> <p>No <input type="checkbox"/></p>
---	--

**B1.2.3.4. Permitted reduction of active power during underfrequency**

<p>Is the active power reduction at underfrequency less than the limit specified in section 4.1.2.2?</p> <p>If yes, please provide reference to documentation:</p>	<p>Yes <input type="checkbox"/></p> <p>No <input type="checkbox"/></p>
--	--

**B1.2.4. Start-up and reconnection of a power-generating plant**

**B1.2.4.1. Start-up and reconnection**

<p>Will start-up and reconnection be performed more than three minutes after the voltage and frequency are within the ranges stated in section 4.2?</p> <p>If yes, please provide reference to documentation:</p>	<p>Yes <input type="checkbox"/></p> <p>No <input type="checkbox"/></p>
---	--

**B1.2.4.2. Active power increase gradient**

<p>Does the power-generating plant comply with the requirement for maximum active power increase at connection as specified in section 4.2?</p> <p>If yes, please provide reference to documentation:</p>	<p>Yes <input type="checkbox"/></p> <p>No <input type="checkbox"/></p>
---	--

**B1.2.5. Active power control**

**B1.2.5.1. Power response to overfrequency**

<p><i>Is the power-generating plant equipped with a frequency response function for overfrequency as specified in section 4.3.1?</i></p> <p><i>If yes, please provide reference to documentation:</i></p>	<p>Yes <input type="checkbox"/></p> <p>No <input type="checkbox"/></p>
---	--

**B1.2.6. Reactive power control**

**B1.2.6.1. Operating range**

<p>Is the power-generating plant capable of supplying reactive power at <math>P_n</math> and varying operating voltages as specified in section 4.4?</p> <p>If yes, please provide reference to documentation:</p>	<p>Yes <input type="checkbox"/></p> <p>No <input type="checkbox"/></p>
<p>Is the power-generating plant capable of supplying reactive power when active power varies as specified in section 4.4?</p> <p>If yes, please provide reference to documentation:</p>	<p>Yes <input type="checkbox"/></p> <p>No <input type="checkbox"/></p>

**B1.2.6.2. Power Factor control**

<p><i>Is the power-generating plant equipped with a Power Factor control function as specified in section 4.4.2?</i></p> <p><i>If yes, please provide reference to documentation:</i></p>	<p>Yes <input type="checkbox"/></p> <p>No <input type="checkbox"/></p>
---	--

**B1.2.6.3. Automatic Power Factor control**

<p><i>Is the power-generating plant equipped with an automatic Power Factor control function as specified in section 4.4.3?</i></p> <p><i>If yes, please provide reference to documentation:</i></p>	Yes <input type="checkbox"/> No <input type="checkbox"/>
--	---

**B1.2.6.4. Q control**

<p><i>Is the power-generating plant equipped with Q control function as specified in section 4.4.4?</i></p> <p><i>If yes, please provide reference to documentation:</i></p>	Yes <input type="checkbox"/> No <input type="checkbox"/>
--	---

**B1.2.7. Protection**

**B1.2.7.1. Relay settings**

*Please state default relay setting values in the table below. If the default values deviate from those specified in section 4.5.3, please include documentation showing that the relay settings can be adjusted to the correct values during commissioning.*

Protection function	Symbol	Setting		Trip time	
Overvoltage (step 2)	$U_{>>}$		V		ms
Overvoltage (step 1)	$U_{>}$		V		s
Undervoltage (step 1)	$U_{<}$		V		s
Undervoltage (step 2)	$U_{<<}$		V		ms
Overfrequency	$f_{>}$		Hz		ms
Underfrequency	$f_{<}$		Hz		ms
Frequency change	$df/dt$		Hz/s		ms

*Please provide reference to documentation:*

**B1.2.7.2. Additional requirements for grid protection of synchronous power-generating plants**

<p><i>Is synchronous undervoltage relay used to prevent asynchronous connection?</i></p>	Yes <input type="checkbox"/> No <input type="checkbox"/>
--	---

### B1.2.7.3. Additional relay settings for synchronous power-generating plants

Please state the relay settings in the table below.

Protection function	Symbol	Setting	Trip time
Overcurrent	I <sub>&gt;</sub>	A	ms
Synchronous undervoltage*		V	ms

\*If synchronous undervoltage relay is used.

### B1.2.8. Power quality

For each power quality parameter, please specify how the result was obtained.

#### B1.2.8.1. Rapid voltage changes

<p>Does the power-generating plant comply with the limit value for rapid voltage changes specified in section 4.6.1.3?</p> <p>If yes, please provide reference to documentation:</p>	<p>Yes <input type="checkbox"/></p> <p>No <input type="checkbox"/></p>
--	--

#### B1.2.8.2. DC content

<p>Does the DC content during normal operation exceed 0.5% of the nominal current?</p> <p>If no, please provide reference to documentation:</p>	<p>Yes <input type="checkbox"/></p> <p>No <input type="checkbox"/></p>
---	--

#### B1.2.8.3. Current unbalance

<p>Does the current unbalance during normal operation exceed 16 A?</p> <p>Please provide reference to documentation:</p>	<p>Yes <input type="checkbox"/></p> <p>No <input type="checkbox"/></p>
<p>Have steps been taken to ensure that the above limit is not exceeded if the power-generating plant consists of single-phase power-generating units?</p> <p>If yes, please provide reference to documentation:</p>	<p>Yes <input type="checkbox"/></p> <p>No <input type="checkbox"/></p>

**B1.2.8.4. Flicker**

<p><i>Is the flicker contribution for the entire power-generating plant below the limit value specified in section 4.6.1.4?</i></p> <p><i>If yes, please provide reference to documentation:</i></p>	Yes <input type="checkbox"/> No <input type="checkbox"/>
--	---

**B1.2.8.5. Harmonic overtones**

<p><i>Are all the harmonic overtones for the entire power-generating plant below the limit values specified in section 4.6.1.5?</i></p> <p><i>If yes, please provide reference to documentation:</i></p>	Yes <input type="checkbox"/> No <input type="checkbox"/>
--	---

**B1.2.8.6. Interharmonic overtones**

Please only complete this section for power-generating plants above 50 kW.

<p><i>Are all the interharmonic overtones for the entire power-generating plant below the limit values specified in section 4.6.1.6?</i></p> <p><i>If yes, please provide reference to documentation:</i></p>	Yes <input type="checkbox"/> No <input type="checkbox"/>
---	---

**B1.2.8.7. Distortions in the 2-9 kHz frequency range**

Please only complete this section for power-generating plants above 50 kW.

<p><i>Are emissions of distortions in the 2-9 kHz frequency range less than 0.2% of the rated current <math>I_n</math> as required in section 4.6.1.7?</i></p> <p><i>If yes, please provide reference to documentation:</i></p>	Yes <input type="checkbox"/> No <input type="checkbox"/>
---	---

**B1.2.9. Signature**

Date:	
Company:	
Responsible:	
Signature (Responsible):	

## ANNEX 2 DOCUMENTATION FOR TYPE B POWER-GENERATING PLANTS

### B2.1. Documentation for type B power-generating plants (part 1)

Please complete the documentation with power-generating plant data before commissioning and send it to the DSO.

#### B2.1.1. Identification

Power-generating plant name:	
Global Service Relation Number (GSRN-number):	
Plant owner name and address:	
Plant owner telephone number:	
Plant owner e-mail address:	

#### B2.1.2. Description of the power-generating plant

Type:	Synchronous power-generating plant <input type="checkbox"/> Power park module <input type="checkbox"/>
Primary energy source:	Wind <input type="checkbox"/> Solar <input type="checkbox"/> Fuel <input type="checkbox"/> Other* <input type="checkbox"/>
*Describe type:	
Energy conversion technology:	Steam turbine <input type="checkbox"/> Gas turbine <input type="checkbox"/> Combined cycle plant <input type="checkbox"/> Internal combustion engine <input type="checkbox"/> Inverter-based <input type="checkbox"/>
Fuel type, if applicable:	
Manufacturer/model:	

Voltage at the POC ( $U_c$ ):	
Nominal power ( $P_n$ ):	
Minimum power ( $P_{min}$ ):	
Rated mechanical shaft power for drive system ( $P_{mech}$ ) (only synchronous plants):	
Is a process diagram available for the plant?  Document reference:	Yes <input type="checkbox"/> No <input type="checkbox"/>
Is a single-line diagram available showing settlement metering, online metering, ownership boundaries and operation manager boundaries?  Document reference:	Yes <input type="checkbox"/> No <input type="checkbox"/>

**B2.1.2.1. Generator data**

Please only complete this section for **synchronous** power-generating plants.

Description	Symbol	Unit	Value
Rated apparent power :	$S_n$	MVA	
Rated voltage:	$U_n$	kV	
Rated frequency:	$f_n$	Hz	
Rated Power Factor ( $\cos\phi$ ):	$\cos\phi_n$	-	
Rated minimum reactive power generation from PQ diagram:	$Q_{min,n}$	Mvar	
Rated maximum reactive power generation from PQ diagram:	$Q_{max,n}$	Mvar	
Synchronous speed:	$n_n$	Rpm	
Total moment of inertia for rotating mass (generator, drive system, etc.):	$J_{tot}$	kg·m <sup>2</sup>	
Total moment of inertia for generator:	$J_G$	kg·m <sup>2</sup>	
Total moment of inertia for drive system:	$J_D$	kg·m <sup>2</sup>	
Rotor type:	-	-	

			Salient poles <input type="checkbox"/> Distinct poles <input type="checkbox"/>
Stator resistance per phase:	$R_a$	p.u.	
Temperature for resistance:	$T_R$	°C	
Stator dispersion reactance per phase:	$X_{ad}$	p.u.	
Positive-sequence reactance, d axis:	$X_d$	p.u.	
Transient reactance, d axis:	$X'_d$	p.u.	
Subtransient reactance, d axis:	$X''_d$	p.u.	
Saturated positive-sequence reactance, d axis:	$X_{d,sat}$	p.u.	
Saturated subtransient positive-sequence reactance, d axis:	$X''_{d,sat}$	p.u.	
Positive-sequence reactance, q axis:	$X_q$	p.u.	
Transient reactance, q axis:	$X'_q$	p.u.	
Subtransient reactance, q axis:	$X''_q$	p.u.	
Transient open circuit time constant, d axis:	$T'_{d0}$	s	
Subtransient open circuit time constant, d axis:	$T''_{d0}$	s	
Transient open circuit time constant, q axis:	$T'_{q0}$	s	
Subtransient open circuit time constant, q axis:	$T''_{q0}$	s	
Potier reactance:	$X_p$	p.u.	
Saturation point at 1.0 p.u. voltage:	$SG_{1.0}$	p.u.	
Saturation point at 1.2 p.u. voltage:	$SG_{1.2}$	p.u.	
Reactance, inverse-component:	$X_2$	p.u.	
Resistance, inverse-component:	$R_2$	p.u.	
Reactance, zero-component:	$X_0$	p.u.	
Resistance, zero-component:	$R_0$	p.u.	
Is the generator star point earthed?	-	-	Yes <input type="checkbox"/> No <input type="checkbox"/>
If yes, ground reactance:	$X_e$	Ohm	
If yes, ground resistance:	$R_e$	Ohm	
Generator's short-circuit ratio (Rated):	$K_c$	p.u.	

### B2.1.2.2. Generator information

This section can be **omitted** for power park modules.

Manufacturer:	
Type/Model:	
Does the generator comply with relevant sections of the following European standards? <ul style="list-style-type: none"> <li>- DS/EN 60034-1, 'Rotating electrical machines – Part 1: Rating and performance', 2004</li> <li>- DS/EN 60034-3 'Rotating electrical machines – Part 3: Specific requirements for turbine-type synchronous machines', 1995</li> </ul>	Yes <input type="checkbox"/> No <input type="checkbox"/>
Is detailed generator documentation enclosed?	Yes <input type="checkbox"/> No <input type="checkbox"/>
If yes, please provide reference to documentation:	

### B2.1.2.3. Excitation system

This section can be **omitted** for power park modules.

Manufacturer:	
Type/Model:	
Does the excitation system comply with relevant parts of the following European standards: <ul style="list-style-type: none"> <li>- DS/EN 60034-16-1:2011 'Rotating electrical machines – Part 16: Excitation systems for synchronous machines – Chapter 1: Definitions'</li> <li>- DS/CLC/TR 60034-16-3:2004 'Rotating electrical machines – Part 16: Excitation systems for synchronous machines – Section 3: Dynamic performance'.</li> </ul>	Yes <input type="checkbox"/> No <input type="checkbox"/>
Is the power-generating plant equipped with excitation system as specified in section 5.4.5?	Yes <input type="checkbox"/> No <input type="checkbox"/>
Is detailed excitation system documentation enclosed?	Yes <input type="checkbox"/> No <input type="checkbox"/>
If yes, please provide reference to documentation:	

**B2.1.2.4. Generator or plant transformer**

This section can be **omitted** for power park modules.

Manufacturer:	
Type/Model:	
Is detailed transformer documentation enclosed?  If yes, please provide reference to documentation:	Yes <input type="checkbox"/> No <input type="checkbox"/>

**B2.1.3. EN50549-1**

Is the power-generating plant in accordance with the requirements in EN50549-1?  If yes, please provide reference to the documentation:  Demands in <i>italic</i> must be answered. Demands in questions with normal letters are included in EN50549-1	Yes <input type="checkbox"/> No <input type="checkbox"/>
---	---

**B2.1.4. Tolerance of frequency and voltage deviations**

**B2.1.4.1. Phase jump**

<i>Does the power-generating plant remain connected during voltage phase jumps of 20 degrees at the POC as specified in section 5.1.1?</i>  <i>If yes, please provide reference to documentation:</i>	Yes <input type="checkbox"/> No <input type="checkbox"/>
---	---

**B2.1.4.2. Operating area for voltage and frequency**

Is the power-generating plant capable of remain connected to the public electricity supply grid within the voltage and frequency range specified in section 5.1.1 and 5.1.2 and on figure 5.1 and generating continuously within the normal operating range.  If yes, please provide reference to documentation:	Yes <input type="checkbox"/> No <input type="checkbox"/>
--	---

**B2.1.4.3. Frequency change**

Will the power-generating plant remain connected in case of frequency changes of 2.0 Hz/s at the POC?  If yes, please provide reference to documentation:  -- <i>To be completed for synchronous power generating plant</i>	Yes <input type="checkbox"/> No <input type="checkbox"/>
---	---

**B2.1.4.4. Permitted reduction of active power during underfrequency**

<p>Is the active power reduction at underfrequency less than the limit specified in section 5.1.2.2?</p> <p>If yes, please provide reference to documentation:</p>	<p>Yes <input type="checkbox"/></p> <p>No <input type="checkbox"/></p>
--	--

**B2.1.5. Tolerance of voltage deviations**

<p>Does the power-generating plant stay connected to the public electricity supply grid during voltage dips as specified in section 5.1.3.3?</p> <p>If yes, please provide reference to documentation:</p>	<p>Yes <input type="checkbox"/></p> <p>No <input type="checkbox"/></p>
<p>Does the power-generating plant stay connected to the public electricity supply grid during voltage swells as specified in section 5.1.3.2?</p> <p>If yes, please provide reference to documentation:</p>	<p>Yes <input type="checkbox"/></p> <p>No <input type="checkbox"/></p>

**B2.1.5.1. Fast fault current**

Please only complete this section for **power park modules**.

<p>Does the power park module supply fast fault current as specified in section 5.1.3.3 (b)?</p> <p>If yes, please provide reference to documentation:</p>	<p>Yes <input type="checkbox"/></p> <p>No <input type="checkbox"/></p>
--	--

**B2.1.6. Start-up and reconnection of a power-generating plant**

<p>Is connection and synchronisation performed as specified in section 5.2?</p> <p>If yes, please provide reference to documentation:</p>	<p>Yes <input type="checkbox"/></p> <p>No <input type="checkbox"/></p>
<p>Is it possible to bypass automatic synchronisation?</p> <p>If no, please provide reference to documentation:</p>	<p>Yes <input type="checkbox"/></p> <p>No <input type="checkbox"/></p>

**B2.1.7. Active power control**

**B2.1.7.1. Frequency response – overfrequency**

<p><i>Is the power-generating plant equipped with a frequency response function for overfrequency as specified in section 5.3.1?</i></p> <p><i>If yes, please provide reference to documentation:</i></p>	<p>Yes <input type="checkbox"/></p> <p>No <input type="checkbox"/></p>
---	--

**B2.1.7.2. Absolute power limit function**

<p><i>Is the power-generating plant equipped with an absolute power limit function as specified in section 5.3.2.1?</i></p> <p><i>If yes, please provide reference to documentation:</i></p>	<p>Yes <input type="checkbox"/></p> <p>No <input type="checkbox"/></p>
--	--

**B2.1.7.3. Ramp rate limit**

<p><i>Is the power-generating plant equipped with ramp rate limit as specified in section 5.3.2.2?</i></p> <p><i>If yes, please provide reference to documentation:</i></p>	<p>Yes <input type="checkbox"/></p> <p>No <input type="checkbox"/></p>
---	--

**B2.1.8. Reactive power control**

**B2.1.8.1. Operating range**

<p><i>Is the power-generating plant capable of supplying reactive power at <math>P_n</math> and varying operating voltages as specified in section 5.4?</i></p> <p><i>If yes, please provide reference to documentation:</i></p>	<p>Yes <input type="checkbox"/></p> <p>No <input type="checkbox"/></p>
<p><i>Is the power-generating plant capable of supplying reactive power when active power varies as specified in section 5.4?</i></p> <p><i>If yes, please provide reference to documentation:</i></p>	<p>Yes <input type="checkbox"/></p> <p>No <input type="checkbox"/></p>

**B2.1.8.2. Power Factor control**

<p><i>Is the power-generating plant equipped with a Power Factor control function as specified in section 5.4.2?</i></p> <p><i>If yes, please provide reference to documentation:</i></p>	Yes <input type="checkbox"/> No <input type="checkbox"/>
---	---

**B2.1.8.3. Automatic Power Factor control**

<p><i>Is the power-generating plant equipped with an Automatic Power Factor control function as specified in section 5.4.3?</i></p> <p><i>If yes, please provide reference to documentation:</i></p>	Yes <input type="checkbox"/> No <input type="checkbox"/>
--	---

**B2.1.8.4. Q control**

<p><i>Is the power-generating plant equipped with Q control function as specified in section 5.4.4?</i></p> <p><i>If yes, please provide reference to documentation:</i></p>	Yes <input type="checkbox"/> No <input type="checkbox"/>
--	---

**B2.1.9. Power quality**

<p><i>Are the values in the provided documentation computed values?</i></p>	Yes <input type="checkbox"/> No <input type="checkbox"/>
<p><i>Are the values in the provided documentation measured values?</i></p>	Yes <input type="checkbox"/> No <input type="checkbox"/>
<p><i>Is a report documenting that the calculations or measurements comply with the emission requirements included?</i></p> <p><i>If yes, please provide reference to documentation:</i></p>	Yes <input type="checkbox"/> No <input type="checkbox"/>

**B2.1.9.1. Rapid voltage changes**

<p><i>Does the plant comply with the limit value for rapid voltage changes specified in section 5.6.1.3?</i></p> <p><i>If yes, please provide reference to documentation:</i></p>	Yes <input type="checkbox"/> No <input type="checkbox"/>
---	---

**B2.1.9.2. DC content**Please only complete this section for **power park modules**.

<p><i>Does the DC content during normal operation exceed 0.5% of nominal current as specified in section 5.6.1.1?</i></p> <p><i>If yes, please provide reference to documentation:</i></p>	<p>Yes <input type="checkbox"/></p> <p>No <input type="checkbox"/></p>
--	--

**B2.1.9.3. Voltage unbalance**Please only complete this section for **power park modules**.

<p><i>Does the plant have balanced three-phase load, as specified in section 5.6.1.2?</i></p> <p><i>If yes, please provide reference to documentation:</i></p>	<p>Yes <input type="checkbox"/></p> <p>No <input type="checkbox"/></p>
--	--

**B2.1.9.4. Flicker**Please only complete this section for **power park modules**.

<p><i>Is the flicker contribution for the entire plant below the limit value specified in section 5.6.1.4?</i></p> <p><i>If yes, please provide reference to documentation:</i></p>	<p>Yes <input type="checkbox"/></p> <p>No <input type="checkbox"/></p>
---	--

**B2.1.9.5. Harmonic overtones**Please only complete this section for **power park modules**.

<p><i>Are all the harmonic overtones for the entire plant below the limit values specified in 5.6.1.5?</i></p> <p><i>If yes, please provide reference to documentation:</i></p>	<p>Yes <input type="checkbox"/></p> <p>No <input type="checkbox"/></p>
---	--

**B2.1.9.6. Interharmonic overtones**Please only complete this section for **power park modules**.

<p><i>Are all the interharmonic overtones for the entire plant below the limit values specified in section 5.6.1.6?</i></p> <p><i>If yes, please provide reference to documentation:</i></p>	<p>Yes <input type="checkbox"/></p> <p>No <input type="checkbox"/></p>
--	--

**B2.1.9.7. Distortions in the 2-9 kHz frequency range**

Please only complete this section for **power park modules**.

<p><i>Are emissions of distortions in the 2-9 kHz frequency range less than 0.2% of <math>I_n</math> as required in section 5.6.1.7?</i></p> <p><i>If yes, please provide reference to documentation:</i></p>	<p>Yes <input type="checkbox"/></p> <p>No <input type="checkbox"/></p>
---	--

**B2.1.10. Protection**

<p><i>Is the plant equipped with the protection functions required in section 5.5.3?</i></p> <p><i>If yes, please provide reference to documentation:</i></p>	<p>Yes <input type="checkbox"/></p> <p>No <input type="checkbox"/></p>
---	--

**B2.1.10.1. Islanding detection**

<p><i>Is the plant equipped with the protection functions required in section 5.5.4?</i></p> <p><i>If yes, please provide reference to documentation:</i></p>	<p>Yes <input type="checkbox"/></p> <p>No <input type="checkbox"/></p>
---	--

**B2.1.10.2. Additional requirements for grid protection of synchronous power-generating plants**

This section can be **omitted** for power park modules.

<p><i>Is a synchronous undervoltage relay used?</i></p>	<p>Yes <input type="checkbox"/></p> <p>No <input type="checkbox"/></p>
<p><i>Is an overcurrent relay used?</i></p>	<p>Yes <input type="checkbox"/></p> <p>No <input type="checkbox"/></p>
<p><i>If yes, please provide reference to documentation:</i></p>	

**B2.1.11. Requirements for information exchange**

<p><i>Is the power-generating plant capable of exchanging information as required in section 5.7?</i></p> <p><i>If yes, please provide reference to documentation:</i></p>	<p>Yes <input type="checkbox"/></p> <p>No <input type="checkbox"/></p>
--	--

**B2.1.12. Signature**

Date:	
Company:	
Responsible:	
Signature (Responsible):	

**B2.2. Documentation for type B power-generating plants (part 2)**

Please complete the documentation with power-generating plant data after commissioning and send it to the DSO.

**B2.2.1. Identification**

Power-generating plant name:	
Global Service Relation Number (GSRN number):	
Plant owner name and address:	
Plant owner telephone number:	
Plant owner e-mail address:	

**B2.2.2. Active power control**

**B2.2.2.1. Active power control at overfrequency**

Is the frequency response function for overfrequency enabled?	Yes <input type="checkbox"/> No <input type="checkbox"/>
If yes, what are the setting values?	
Frequency threshold ( $f_{RO}$ ):	_____ Hz
Droop:	_____ %
Time for islanding detection (minimum response time):	_____ ms

**B2.2.2.2. Absolute power limit function**

<p>Is the absolute power limit function enabled?</p>    <p>If yes, which set point value is used?</p>	<p>Yes <input type="checkbox"/></p> <p>No <input type="checkbox"/></p> <p>Controlled online <input type="checkbox"/></p> <p>_____ kW</p>
---	--

**B2.2.2.3. Ramp rate limit**

<p>Is the power-generating plant ramp rate limit enabled?</p>    <p>If yes, which set point value is used?</p>	<p>Yes <input type="checkbox"/></p> <p>No <input type="checkbox"/></p> <p>Controlled online <input type="checkbox"/></p> <p>_____ % P<sub>n</sub>/min</p>
--	---

**B2.2.3. Reactive power control**

**B2.2.3.1. Q control**

<p>Is the Q control function enabled?</p>    <p>If yes, which set point is used? (Values different from 0 kVAR must be agreed with the DSO)</p>	<p>Yes <input type="checkbox"/></p> <p>No <input type="checkbox"/></p> <p>Controlled online <input type="checkbox"/></p> <p>_____ kVAR</p>
---	--

**B2.2.3.2. Power Factor control**

<p>Is the Power Factor control function enabled?</p>    <p>If yes, which set point is used? (Values different from cosφ 1.0 must be agreed with the DSO)</p>	<p>Yes <input type="checkbox"/></p> <p>No <input type="checkbox"/></p> <p>Controlled online <input type="checkbox"/></p> <p>_____ cosφ</p> <p>Inductive <input type="checkbox"/></p> <p>Capacitive <input type="checkbox"/></p>
--	---

**B2.2.3.3. Automatic Power Factor control**

Is the automatic Power Factor control function enabled? (Must only be enabled subject to prior agreement with the DSO)	Yes <input type="checkbox"/> No <input type="checkbox"/>
If yes, which set points are used?	_____ %
Set point 1 – P/Pn	_____ cosφ
Set point 1 – Power Factor (inductive)	_____ %
Set point 2 – P/Pn	_____ cosφ
Set point 2 – Power Factor (inductive)	_____ %
Set point 3 – P/Pn	_____ cosφ
Set point 3 – Power Factor (inductive)	_____ %

**B2.2.4. Protection**

**B2.2.4.1. Relay settings**

Please state the actual values at the time of commissioning in the table below.

Protection function	Symbol	Setting		Trip time	
Overvoltage (step 2)	$U_{>>}$		V		ms
Overvoltage (step 1)	$U_{>}$		V		s
Undervoltage (step 1)	$U_{<}$		V		s
Overfrequency	$f_{>}$		Hz		ms
Underfrequency	$f_{<}$		Hz		ms
Frequency change	df/dt		Hz/s		ms

**B2.2.4.2. Islanding detection**

Are vector jump relays or active islanding detection used?	Yes <input type="checkbox"/> No <input type="checkbox"/>
--	---

**B2.2.4.3. Additional relay settings for synchronous power-generating plants**

This section can be **omitted** for power park modules.

Please state the actual relay setting values at the time of commissioning in the table below.

Protection function	Symbol	Setting		Trip time	
Overcurrent	$I_{>}$		A		ms
Synchronous undervoltage*			V		ms

\*If synchronous undervoltage relay is used.

**B2.2.5. Conformance testing**

<p>Is a plan for conformance testing available as specified in sections 5.8.2?</p> <p>If yes, please provide reference to documentation:</p>	<p>Yes <input type="checkbox"/></p> <p>No <input type="checkbox"/></p>
--	--

**B2.2.6. Signature**

Date:	
Installation contractor:	
Commissioning manager:	
Signature (commissioning manager):	
Plant owner:	
Signature (plant owner):	